

Bodo's Power Systems®

Electronics in Motion and Conversion

December 2017



 **Navitas**

65W USB-PD

From Science Fiction to Industry Fact: GaN Power ICs Enable the New Revolution in Power Electronics

Forty years ago, in 1977, two major events changed the lives of many engineers: the movie “Star Wars” was released, and there was a revolution in power electronics. By 2017, we have had many Star Wars movies, many more new engineers and finally, the next revolution in power electronics.

By Stephen Oliver, Lingxiao Xue, Peter Huang, Navitas Semiconductor

Back in the late 1970's, the power electronics industry experienced an extraordinary and disruptive change, with the introductions of new switch technology, new integrated controllers, improved magnetics and the industry validation of previously academic-only power topologies.

The silicon bipolar-junction transistor was surpassed in on-state and switching performance by the development of commercial power MOSFETs such as International Rectifier's 'HEXFET'. With the new, 'fast' powertrain components came advances in magnetic materials. Now, switching regulator topologies or 'switched-mode power supplies' (SMPS), challenged the dominance of traditional linear regulators which had utilized bipolar transistors since the beginning of the electronics era, offering the promise of higher efficiencies, higher densities and possibly even lower cost. Initially, however, they were complex to design and the power industry was unfamiliar with and wary of these new "fast" converters. Device integration, in the form of analog application-specific ICs (ASICs) developed by Silicon General, Unitrode & others, was the catalyst to enable simple, cost-effective and industry-proven designs.

In the following decade, the power supply industry experienced a 5x increase in power density, a 5x reduction in losses and a 3x reduction in costs (Figure 1). The next 30 years saw incremental improvements - for example Si superjunction devices, synchronous rectification, resonant topologies - but no performance shifts as dramatic as the first revolution.

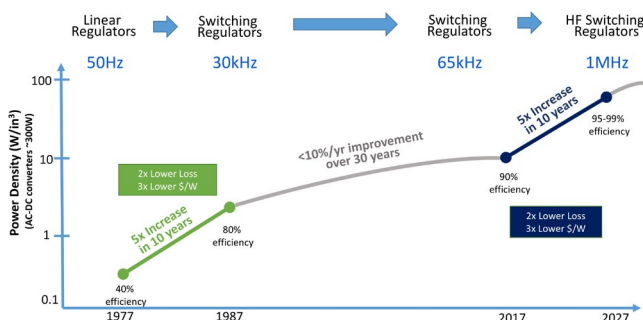

Figure 1: Revolutions in converter speed (switching frequency), performance (efficiency, power density).

Today in 2017, we are again at the start of a new performance revolution, with wide bandgap materials, enhanced high-frequency magnetics, new controllers, enabled topologies and device integration.

Wide Bandgap Gallium Nitride

Gallium Nitride (GaN) is a 'wide bandgap' (WBG) device. This refers to the energy required to free an electron from its orbit around the nucleus and allow it to move freely through the solid. The bandgap determines the electric field that the solid is able to withstand. Si has 1.1 eV, and GaN has a bandgap of 3.4 eV. As WBG material allows high electric fields, depletion regions can be very short or narrow, so device structures can have high carrier density and be packed very densely. A typical 650 V lateral GaN transistor can support over 800 V and has a drain drift region of 10-20 μm , or about 40-80 V/ μm . This is substantially above the theoretical limit of silicon at about 20 V/ μm , but still well short of the bandgap limit of about 300 V/ μm . This leaves substantial room for generational improvements in lateral GaN devices in the future. In device-level terms (normalized $R_{\text{DS(ON)}} \times Q_{\text{G}}$), GaN can be 5x-20x better than Si, depending on implementation [1].

GaN has been used in light-emitting diode form since the 1990s, in Blu-ray players introduced from 2003 and in RF transmitters / amplifiers. GaN transistors can operate at much higher temperatures and work at much higher voltages than gallium arsenide (GaAs) transistors, so they make ideal power amplifiers at microwave frequencies.

For switch-mode power supplies, power GaN took another 10-15 years to evolve from academic curiosity to industry-proven platform. Substrate selection and the development of low-defect GaN epitaxy have been major issues. Originally, power GaN devices were developed on the same substrate material as LEDs and RF devices, primarily sapphire and silicon carbide respectively. Even with GaN's die-size advantage due to very low specific on-resistance (0.2-0.5 $\text{Ohm}\cdot\text{mm}^2$ at 650 V today) compared to state-of-the-art silicon superjunction technology (1-2 $\text{Ohm}\cdot\text{mm}^2$), this led to extremely expensive prototypes. Lateral devices were prototyped and GaN-on-SiC showed promise due to improved thermal performance but devices were still too expensive for power applications. Devices using 4" (100mm) GaN-on-Si wafers were developed, applying lessons learned from early RF transistor attempts to achieve lower cost. Initially, these devices were limited to depletion mode (dMode or 'normally-on') types and suffered from the current collapse or dynamic $R_{\text{DS(ON)}}$ phenomenon, and trap-related long-term stress instability that prevented their

adoption. Finally, 6" (150 mm) production-quality GaN-on-Si wafers have become available for high performance enhancement mode (eMode or normally off) lateral GaN devices, using existing foundry processes. The result is the manufacture of high-volume, cost-effective switches and power ICs.

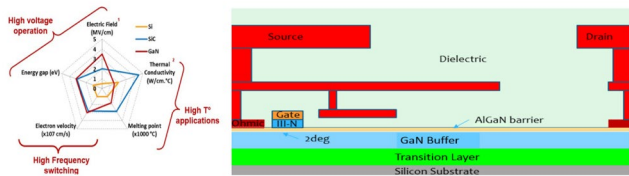

Figure 2: GaN device performance vs Si, SiC, and AlGaIn™ GaN-on-Si device cross-section.

For lateral GaN, a two-dimensional electron gas (2DEG) with AlGaIn/GaN heteroepitaxy structure (see Figure 2) gives very high mobility in the channel and drain drift region. A 2DEG is the result of the difference in bandgap voltage between the two layers, which induces a quantum well at the interface. This well collects electrons in a sheet of charged carriers that are free to move laterally with extremely low resistance. The lateral device structure achieves extremely low gate charge (Q_g) due to the very small fraction of the area covered by the gate. The output charge Q_{OSS} determines the amount of energy required to switch the output state of the transistor and is also very low, due to the small size of the transistor, the insulating GaN epi layer, and the short drain drift region enabled by the high critical electric field.

High-Frequency Magnetics

The revolution of the late 1970's involved a leap from slow, line-frequency (47-63 Hz) magnetic materials to (at that time) 'high-speed' ferrites capable of handling energy efficiently at 10's of kHz. Even today, the vast majority of off-line power converters still switch at 65 kHz – 100 kHz due to several perceived challenges; the first being awareness of available material. In fact, several companies have introduced high-performance, MHz-switching ferrites over the last 10-15 years, as shown simply in Figure 3, and a comprehensive review and formulation of a modified magnetic performance factor has been introduced by researchers at MIT [2].

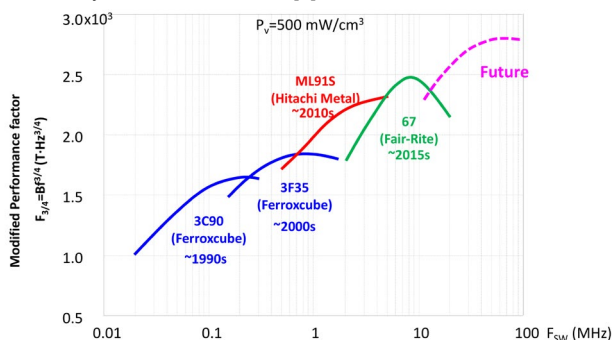

Figure 3: Advances in magnetic materials vs. frequency and time.

EMI is another factor in frequency selection, as the EN55022 regulation has a drop in allowed conducted radiation at 150 kHz, so care must be taken in reference to the second harmonic of the primary switching frequency. However, with careful transformer design, high-frequency systems can be made both to comply with regulations and simultaneously, due to the high frequency, use smaller, cheaper EMI filters [3].

Another factor has been the lack of a fast switch, addressed earlier, and the scarcity of high-frequency controllers, to which we will now turn.

High-Frequency Controllers

For academics investigating and inventing new, high-speed topologies, the availability of high clock-rate digital signal processors (DSPs) offers a convenient way to implement and evaluate new concepts. High-speed, full-power efficiency can be assessed and new power-density metrics achieved [4]. The same DSPs are also used in high power, generally 1kW+, systems which are focused largely on efficiency at medium or full load conditions, achieving various 'Energy Star' ratings for server systems. However, in the mobile and consumer markets, a different set of legislative efficiency standards [5], such as the US Department of Energy's Level VI and the European Union's Certificate of Compliance (CoC) Tier 2 apply, and where the cost and high standby power draw from DSPs make them unusable. Here, dedicated ASICs are needed to address simultaneous performance and cost concerns.

We have addressed high-power (1 kW+) systems above. For mid-power systems, recent PFC and LLC controllers are commercially available to increase switching frequency by 2x-4x today with further advances on the roadmap. For low powers (20-65 W), new, high-frequency Active Clamp Flyback (ACF) controllers are sampling now and will be in production in 2018.

New Topologies

As the 1970's saw the tectonic shift from slow, linear supplies to 'fast' switched-mode power supplies (SMPS), today's change is also enabled by 'academic-only' topologies (complex, hand-crafted, large, expensive) becoming accepted industry standard practice, with high-performance, low-cost ASICs and complete understanding and validation across all necessary real-world operational conditions and power supply reliability and test procedures.

Resonant topologies have also been around almost as long as electricity has been available to use, but their adoption has been limited to a relatively narrow application space. With GaN FETs, resonant circuits can enable a dramatic increase in switching frequencies while increasing energy efficiencies compared to hard-switching topologies, creating another dramatic increase in power densities. Past resonant designs were complex and expensive. Some, such as LLC and ACF converters, require a second high-performance transistor and fast high-side level-shifters & gate-drivers to create zero voltage switching (ZVS) over the full operating range. Now, just as analog ASICs simplified and lowered costs of the early switching regulators, GaN power ICs are available to integrate the high-side switches, level-shifters & other critical analog circuits to simplify high-frequency resonant designs and deliver system costs that are lower than their low-frequency, hard-switching counterparts.

At high power levels, the hard-switching constant-current mode (CCM) power factor correction (PFC), whether in simple boost format or in 'bridge-less' or 'totem-pole' variations can be converted to soft-switching critical-conduction mode (CrCM), also known as boundary conduction mode (BCM) and free the converter to run at high frequencies to shrink inductors. At the same time, this highlights another benefit of eMode GaN vs. superjunction Si, in that GaN's extremely-low Q_{OSS} , E_{OSS} figures of merit enables cool running in stark contrast to Si's non-linear capacitance and extreme overheating at increased frequencies [6].

Device Integration

In the 1970's, device integration meant the introduction of commercially viable controllers to replace discrete operational amplifiers and a host of resistors and capacitors. Initially, this was for ease-of-use but became essential for system performance and then cheaper than the bag of parts replaced. In 2017, this integration addresses the complexity, weakness and cost of controlling and driving discrete GaN FETs.

The earliest GaN power devices were dMode (depletion mode) which meant that they needed an additional Si FET in 'cascode' to keep them off, with subsequent negative results in packaging inductance and cost. Later, eMode (enhancement mode) GaN discrete devices had vulnerable gates and a very low threshold voltage. This made them very susceptible to noise and voltage spikes due to high-frequency and high dv/dt noise from the surrounding switched-mode converter circuit, so required complex and expensive control and gate drive circuits [7]. Additionally, both implementations restricted the high-frequency performance of the GaN switch, to the point where there was minimal, if any, advantage over Si, so limiting market adoption.

First demonstrated at APEC 2015, AllGaN™ is the industry's first GaN Power IC Process Design Kit (PDK) which allows monolithic integration of 650V GaN IC circuits (drive, logic) with GaN FETs [8]. Other functions can also be included, such as hysteretic digital input, voltage regulation and ESD protection – all in GaN, as shown in Figure 4. This monolithic integration of drive and switch is impossible using vertical GaN, dMode GaN or SiC.

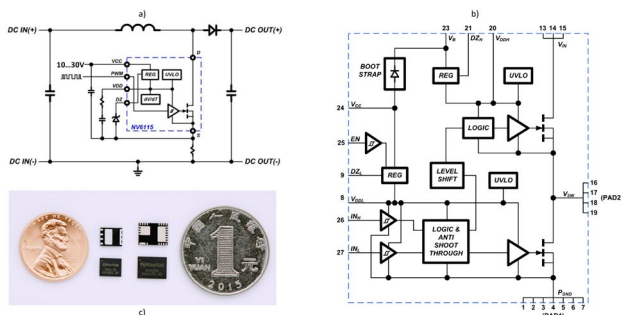

Figure 4: a) Single GaN Power IC with AllGaN monolithic integration of FET, drive and logic, b) Half-Bridge GaN Power IC adds level-shifter, bootstrap-charging circuit, shoot-through protection, etc., c) QFN packages for single (5x6 mm) and half-bridge (6x8 mm) GaN Power ICs.

Now, device integration means that the eMode GaN gate has a precisely-controlled drive voltage to ensure optimum device performance while at the same time – and with no gate-drive loop impedance ensures fast, controlled switching, and as a bonus, the gate is internal to the power IC structure, protecting it from any external or parasitic-induced noise [9]. For this revolution, integration not only makes it simple for the power designer, it also makes it work.

Using the AllGaN PDK, single 650 V-rated GaN Power ICs have been introduced with all the benefits of high-performance eMode GaN (low $R_{DS(ON)}$, low Q_G , zero t_{rr}) but now with the essential advantages of a power IC, for example 1 kV ESD protection, robust 200 V/ns dV/dt slew-rate capability and programmable dV/dt. Taking the concept still further, complete, 2 MHz-rated half-bridge GaN Power ICs have been introduced with two FETs, two drivers, level-shifter, bootstrap charging, shoot-through protection, and many more features, as shown in Figure 4b [10]. In all cases, the power ICs approach the concept of

the 'ideal switch' with excellent on-state and switching performance. With standard 3.3 V, 5 V or 12 V low current logic inputs – they are flexible, 'digital-in, power-out' functional building blocks.

In addition to speed and control benefits, the integrated GaN level-shifter enables a smaller, higher-efficiency and lower-cost solution vs. inductive- or capacitive-coupled techniques, to the ubiquitous high-voltage half-bridge circuits found in the majority of modern applications [11]. A 20x reduction in PCB area and an 80% reduction in parts-count can be achieved [12].

Now all of the elements are in place, let's look at a practical example for the new power electronics revolution, with a special focus on a high-volume consumer / mobile application with extreme performance, legislative and cost demands.

A Revolutionary Converter

While laptop computers have advanced tremendously in cost, capability and features over the last 10-20 years, the AC-DC power adapter or 'brick' has largely remained large and heavy, still utilizing low-frequency, hard- or quasi-hard-switching topologies, slow Si FETs and large magnetics, with efficiencies around 85%-90% (at 90 V_{AC}, full load) and power density around 5-10 W/in³.

As market demand for small size, plus the ease-of-use / flexibility of Universal Serial Bus Type C Power Delivery (USB-PD) has increased, along with simultaneous legislative efficiency requirements such as DoE Level VI and Euro CoC mean that the designer staying with old, slow Si-based switching topologies is forced into more extreme and complex construction / thermal techniques with increase costs.

Thankfully, the new revolution in power conversion liberates the designer from their struggle. Let's revisit the elements of switch, magnetics, topology, controllers and integration and how they combine to achieve a performance breakthrough for a 65 W, USB-PD laptop adapter.

For converters up to 65 W (the adapter PFC/THD threshold), the Quasi-Resonant Flyback (QRF) has been the dominant solution but its inherent snubber circuit and partial hard-switching mean that performance improvements over the last 10 years have been asymptotic with diminishing returns vs. invested effort. The ACF [13] is not a new topology, but only now in late 2017, with the arrival of high-speed and low-cost GaN Power ICs have ACF ASICs been introduced that are high-performance, enable industry / legislative standards and are cost-effective as parts of a high-frequency solution. A first step switching frequency to 300 kHz (with standard bobbin-based transformer) is used in this 65 W example, with later steps to 600 kHz and 1 MHz forecasted using planar magnetics. At 300 kHz, there are several magnetic materials available from Hitachi Metals, TDK, etc.

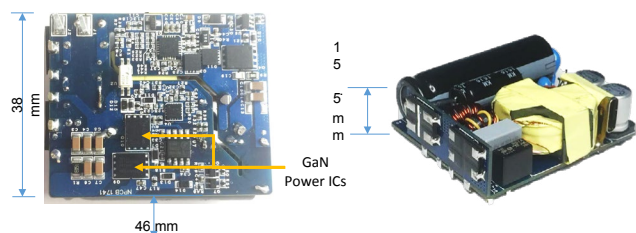

Figure 5: 65 W USB-PD ACF adapter using GaN Power ICs

The high level of device integration and high switching-frequency results in a very compact design, only 38 x 46 x 15.5 mm for PCB and components, with a total size of 27 cc uncased, or 45 cc cased. The power density of 2.4 W/cc (39 W/in³) uncased, and 1.5 W/cc (24 W/in³) cased is 3x-5x better than typical adapters and is the world-wide best-in-class. The adapter is shown in Fig. 5. Note that unlike other converters, the GaN Power IC-based design, demonstrated at CPSSC 2017 [14] meets all USB-PD, DoE and CoC requirements with a simple, standard, low-cost construction.

Figure 6 shows overall efficiency, noting high 93.4% at the critical 90 V_{AC}, full load point, and figure 7 shows compliance with DoE, CoC requirements. Standby performance is 25 mW at 115 V_{AC}, and 40 mW at 230 V_{AC} (vs. CoC specification max of <=75 mW, <=210 mW respectively). Figure 8 shows an example waveform with compliance to USB-PD.

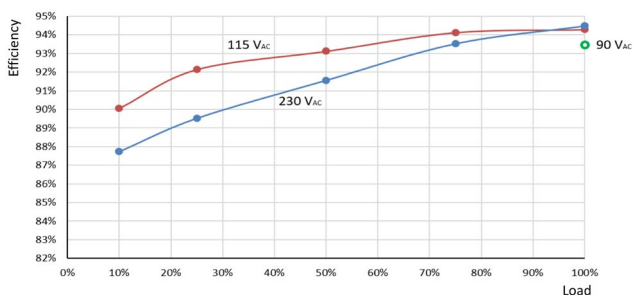

Figure 6: Efficiency vs. load, vs. AC line voltage (measured at PCB, room ambient, no airflow, no heatsink).

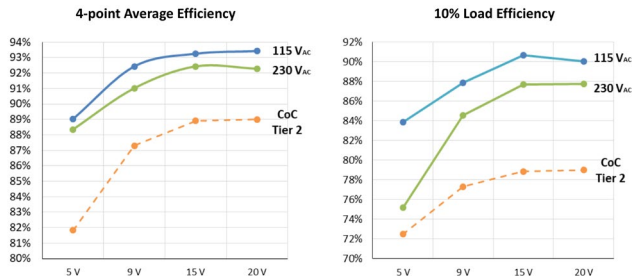

Figure 7: a) Compliance with European Union CoC T2 4-point average efficiency vs. USB-PD output voltage, b) Compliance with CoC 10% load efficiency.

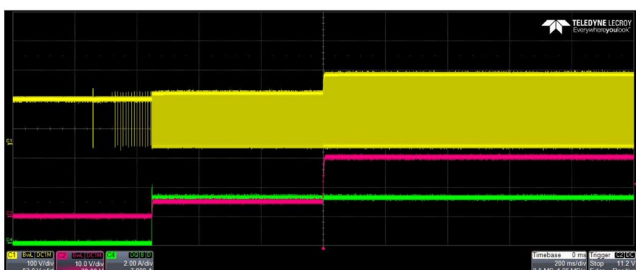

Figure 8: 65 W USB-PD startup waveforms at 115 V_{AC} with a 20 V-capable PD sink. Yellow: switch node voltage; Red: output voltage; Green: output current. Converter first outputs 5 V and then increases to 20 V after high power setting has been negotiated.

Conclusion

Forty years after Star Wars and the first revolution in power electronics, we are now at the start of the second major change. The critical combination of switch, magnetics, topology, control and integration liberates the power designer to stretch beyond the old, slow converters to achieve once again the major leaps in efficiency, power density and cost. This is only the beginning of the new revolution. From previously unimagined, 'science fiction' concepts, GaN Power ICs deliver 'industry facts' with proven performance.

References

- [1] "GaN-on-Si Power Technology: Devices and Applications", Chen et al, IEEE Transactions on Electron Devices, vol. 64, No. 3, March 2017
- [2] "Measurements and Performance Factor Comparisons of Magnetic Materials at High Frequency", A. Hanson et al, MIT, IEEE TRANSACTIONS ON POWER ELECTRONICS, VOL. 31, NO. 11, NOVEMBER 2016
- [3] "Conducted EMI Analysis and Filter Design for MHz Active Clamp Flyback Front-end Converter", A. Huang et al, CPES, APEC 2016.
- [4] "Adaptive Zero-Voltage-Switching Control and Hybrid Current Control for High Efficiency GaN-Based MHz Totem-Pole PFC Rectifier", Huang, et al, NCSU, IEEE APEC 2017
- [5] "Efficiency standards for external power supplies", CUI, <http://www.cui.com/efficiency-standards>
- [6] "COSS hysteresis in advanced superjunction MOSFETs", J. Fedison, M. Harrison, Enphase, APEC 2016
- [7] "Make it Easy with GaN Power ICs", T. Ribarich, Navitas, Bodo's Power, May 2016.
- [8] "Breaking Speed Limits with GaN Power ICs", D. Kinzer, APEC 2016 keynote.
- [9] "GaN Power ICs: Device Integration Delivers Application Performance", N. Fichtenbaum, IEEE WIPDA 2017
- [10] "Half-Bridge GaN Power ICs: Performance & Application", N. Fichtenbaum, et al, IEEE Power Electronics Magazine, Vol. 4, No. 3, Sep., 2017.
- [11] "Next-generation GaN Isolators / Level-Shifters for High Frequency, High Efficiency Power Conversion", M. Giandalia, S. Oliver, PSMA Industry Session, APEC 2017
- [12] "Next-generation GaN Isolators / Level-Shifters for High Frequency, High Efficiency Power Conversion", M. Giandalia, S. Oliver, PSMA Industry Session, APEC 2017
- [13] "Utilization of an active-clamp circuit to achieve soft switching in flyback converters", R. Watson, F.C. Lee, G.C. Hua, Virginia Tech, Power Electronics Specialists Conference, PESC '94 Record., 25th Annual IEEE.
- [14] "High-Frequency Eco-System Drives New Applications, New Solutions", S. Oliver, CPSS-PSMA Joint Workshop, CPSSC 2017.

www.navitassemi.com



Stephen Oliver

Stephen Oliver is VP Sales & Marketing for Navitas Semiconductor. He has over 25 years' experience in the power semiconductor and power supply industries. He holds a B.Eng (Hons) in Electrical & Electronic Engineering from Manchester University, UK and an MBA in Global Marketing & Strategy from UCLA, USA. Stephen holds several patents in power semiconductors, is a Chartered Engineer and is currently President of the Power Sources Manufacturers' Association (PSMA).

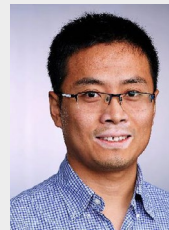

Lingxiao (Lincoln) Xue

Lingxiao (Lincoln) Xue is a Staff Applications Engineer in Navitas Semiconductor. He received his Bachelor's and Master's degree in Zhejiang University, Hangzhou, China in 2006 and 2008, respectively. Lingxiao has presented 20 technical papers and has 3 patents in GaN and high-frequency power conversion granted / pending.



Peter (Wan Nian) Huang is Navitas Semiconductors' Director of Field Applications and Technical Marketing for China & Taiwan. Prior to Navitas, Peter held design, applications and technical marketing roles. He holds a Bachelor's Degree in Electrical Engineering from South China University of Technology, Guangzhou, China and a Master's in Power Electronics from the University of Western Ontario, Canada.