



# GaN Power ICs and the High Frequency Eco-System

April 21<sup>st</sup> 2016

Stephen Oliver, VP Marketing & Sales

[stephen.oliver@navitassemi.com](mailto:stephen.oliver@navitassemi.com)

# Frequency → Density → Efficiency

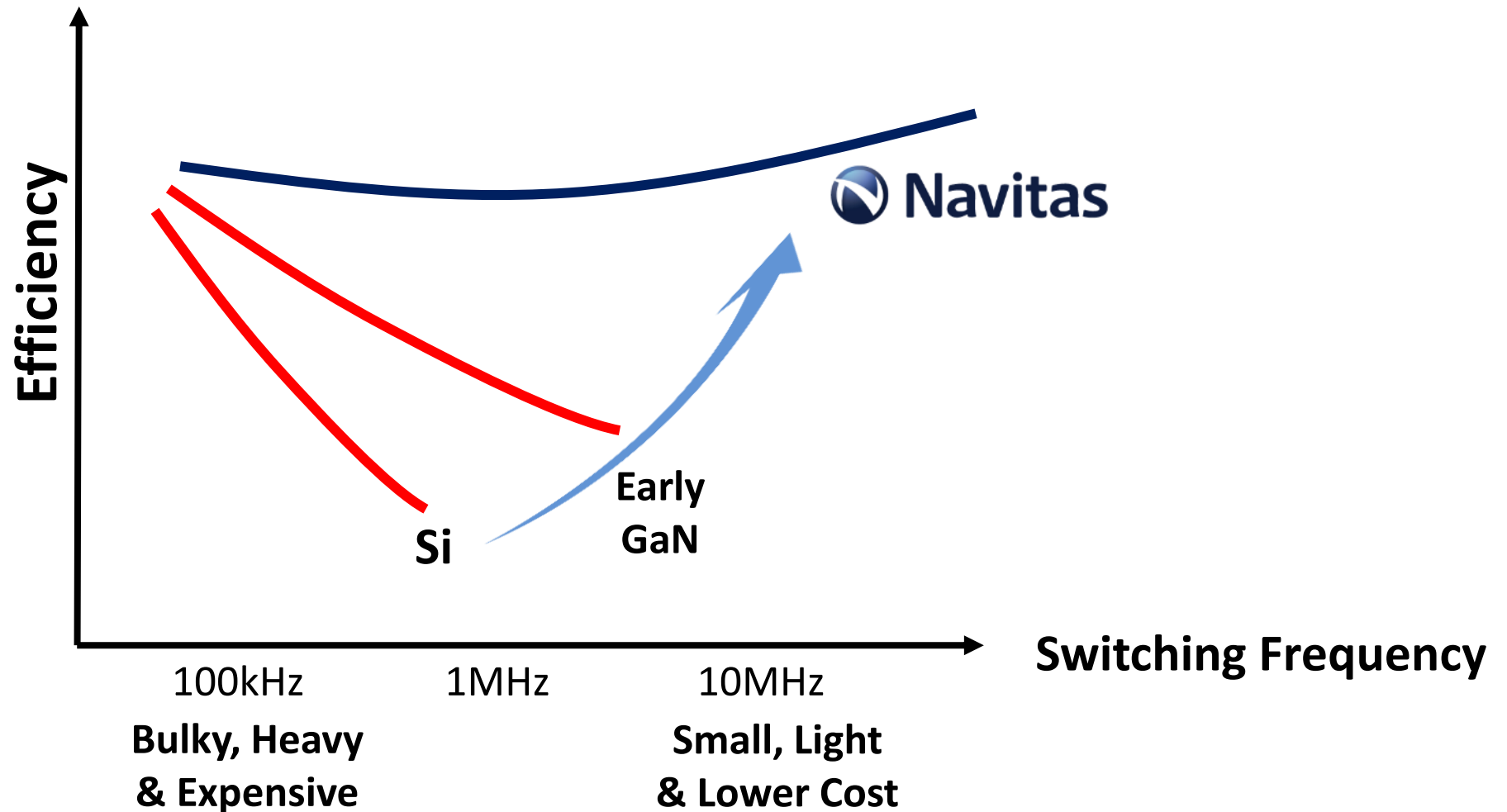

# Looking for an Eco-System!



Magnetics:

# Can Magnetics Rise to the Speed Challenge?

- Boundaries vary with material, DC/AC current mix, power, etc.
- Majority of mass production applications run 65kHz – 150kHz
- 5x frequency increase is within today's capability

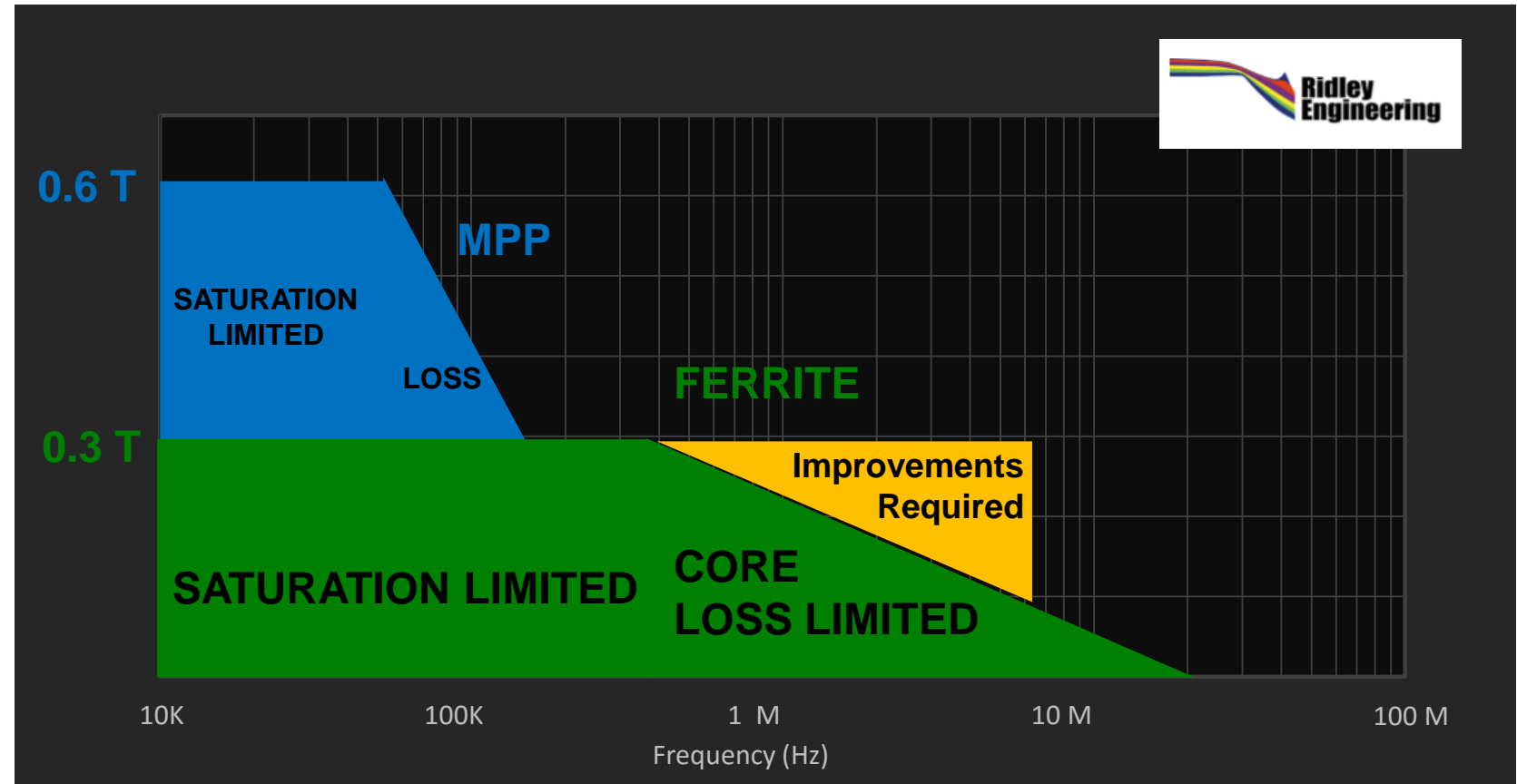

# High Frequency Magnetics 'GaN Optimized'

N59 optimized for 2MHz

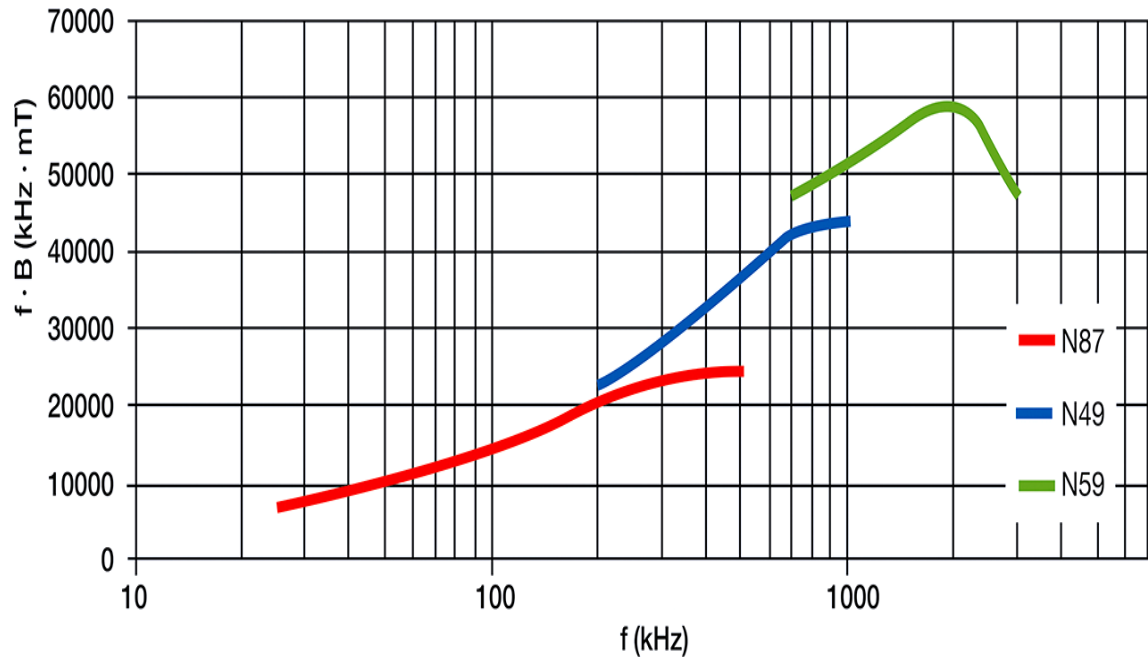

3F & 4F up to 10MHz

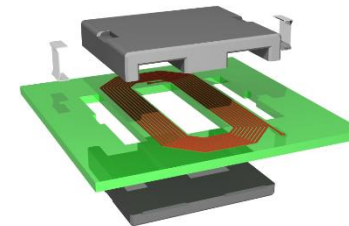
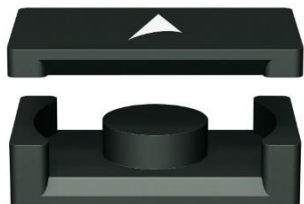
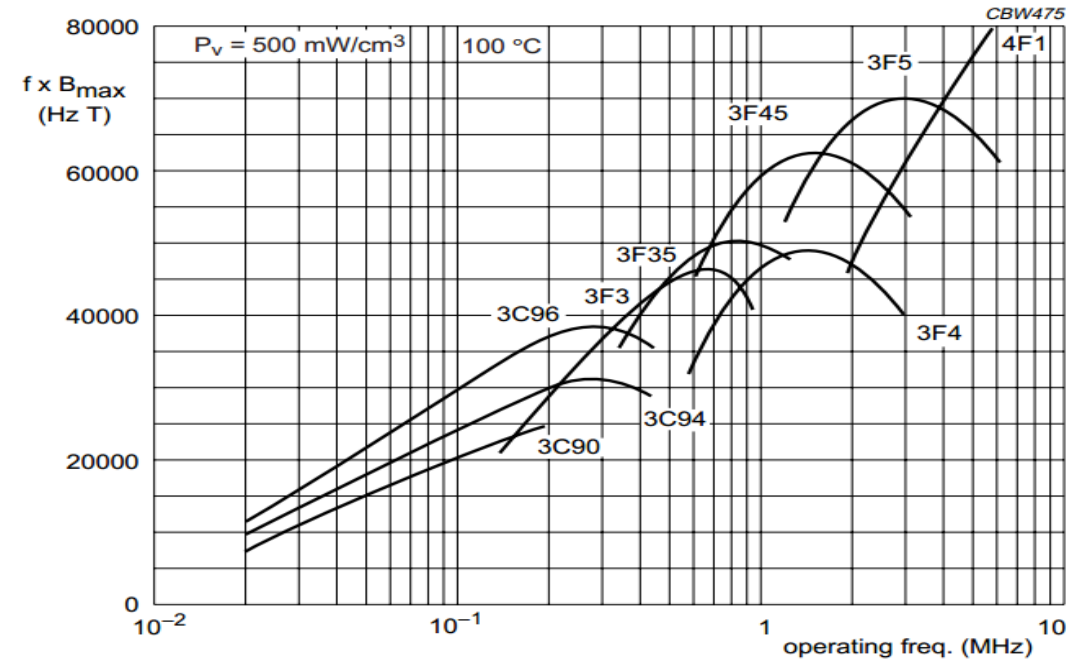

# Higher Frequency = Smaller, Cheaper

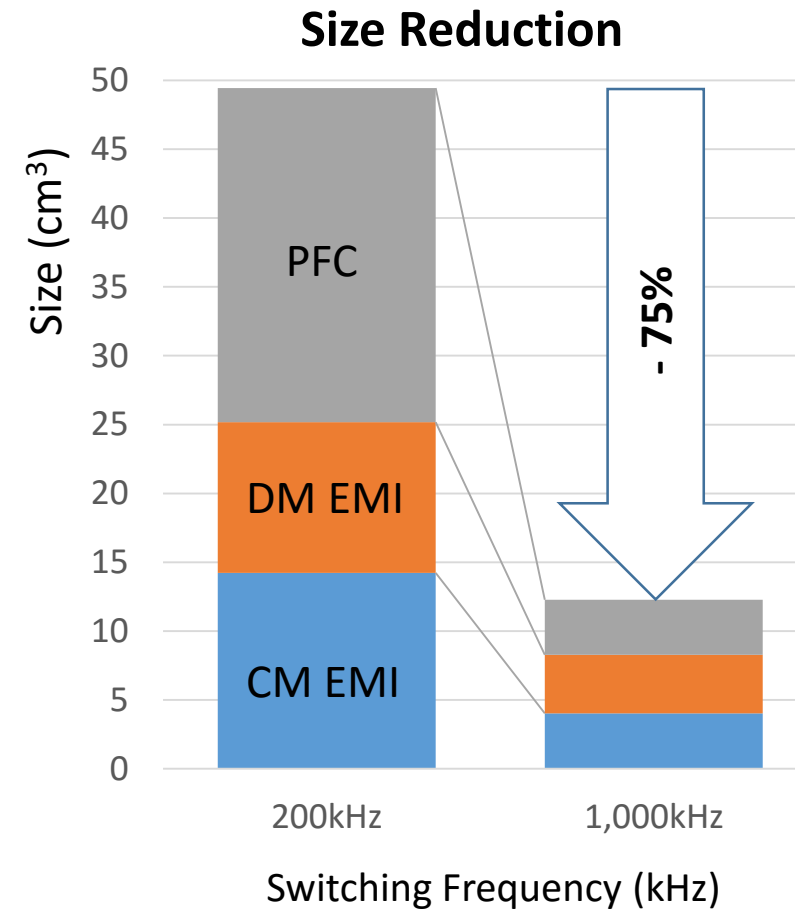
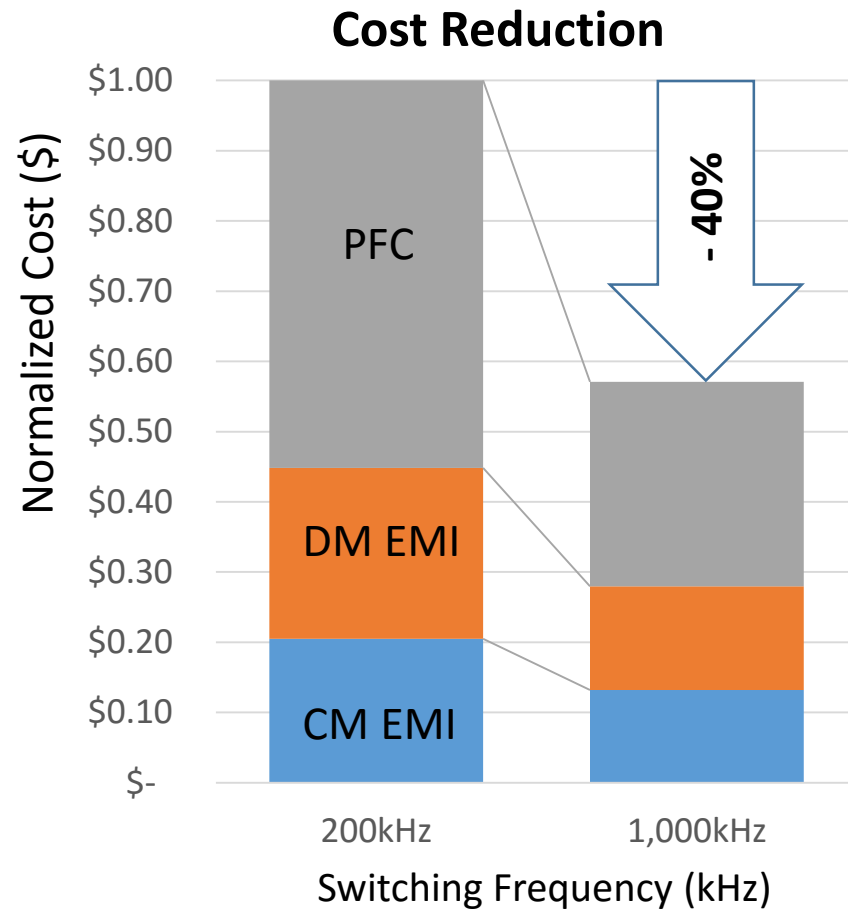

Switch:

# Physics Drives Switch Performance

- WBG GaN material allows high electric fields so high carrier density can be achieved
- Two-dimensional electron gas with AlGaN/GaN heteroepitaxy structure gives very high mobility in the channel and drain drift region
- Lateral device structure achieves extremely low  $Q_g$  and  $Q_{OSS}$  and allows integration

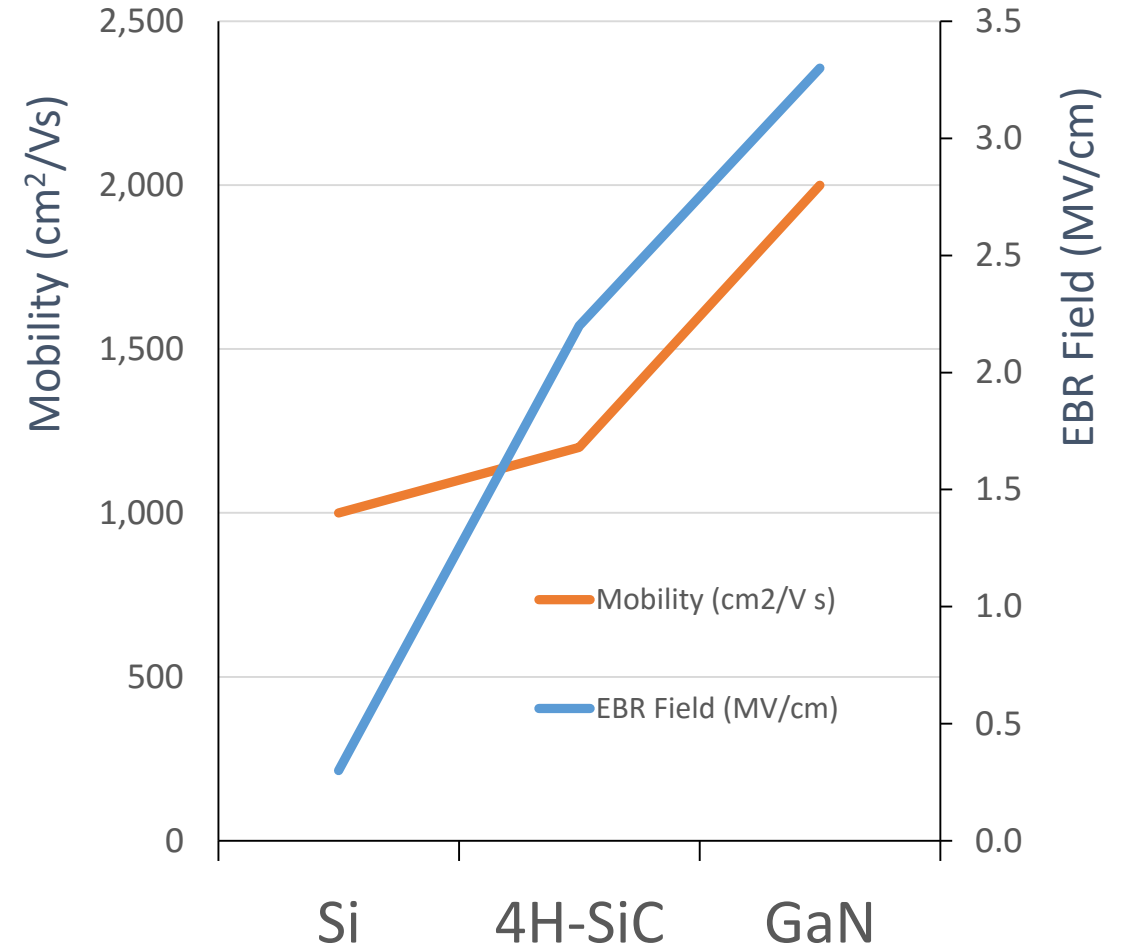
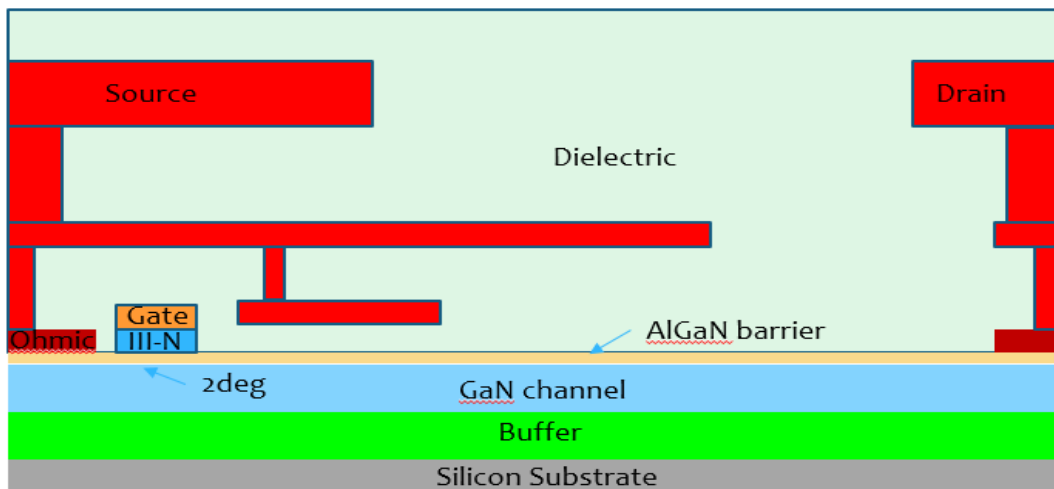

Switch:

# 650V eMode GaN at 27MHz & 40MHz

Class Phi-2 DC/AC converter: Stanford / Navitas demo

- 50% less loss than RF Si
- 16x smaller package
- Air-core inductors
- Minimal FET loss
- Negligible gate drive loss

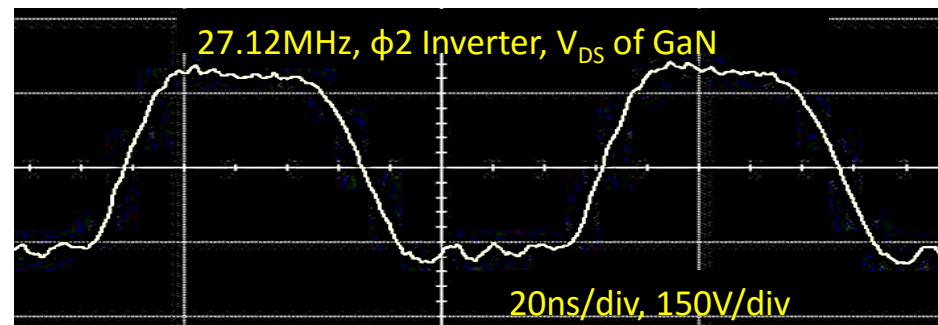
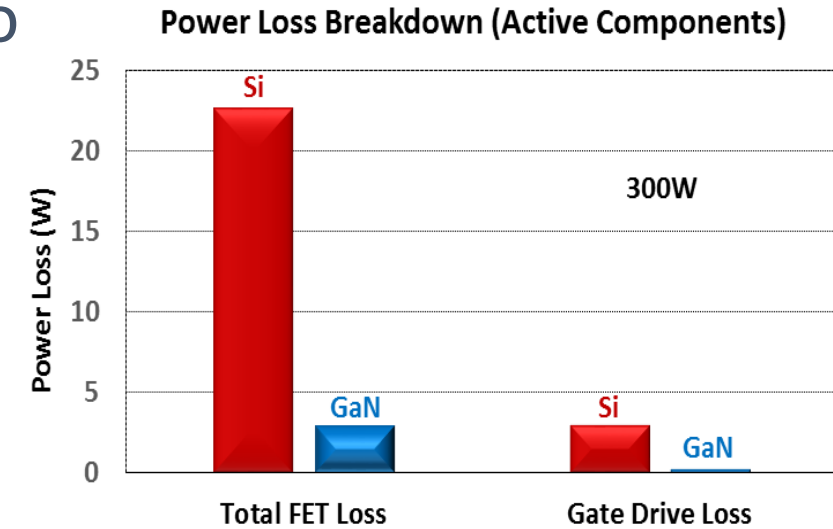
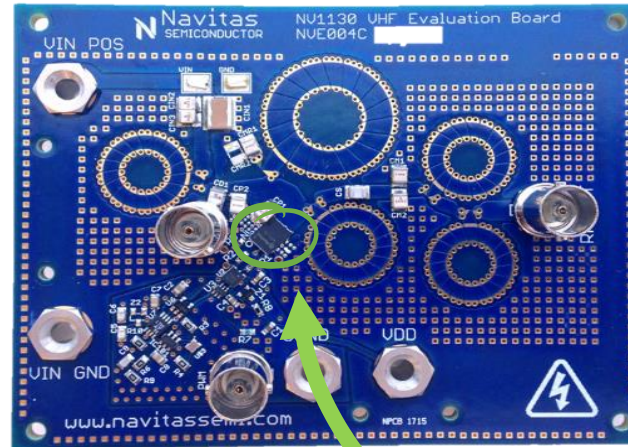
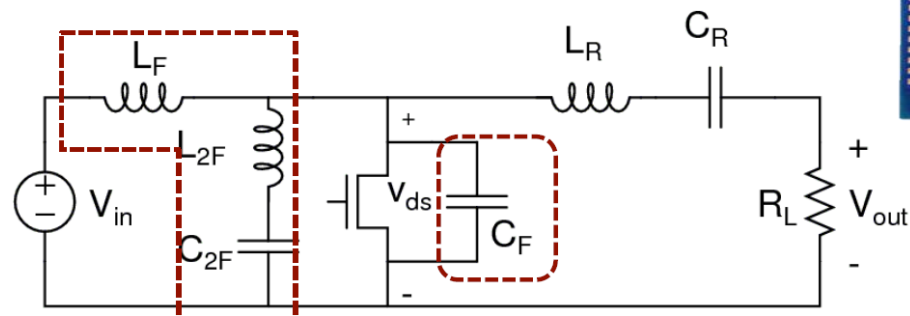

Technology	V	Pack (mm)	$F_{sw}$ (MHz)	Eff. (%)	Power (W)
RF Si (ARF521) 	500	M174 22x22 	27.12	91%	150
eMode GaN 	650	QFN 5x6 	27.12	96%	150
			40.00	93%	115



# Package / Drive: Early GaN

Cascoded dMode Parasitics

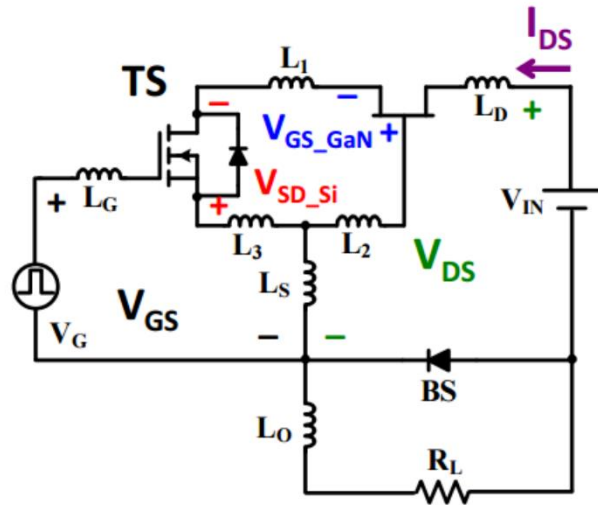

Complex  
Embedded eMode

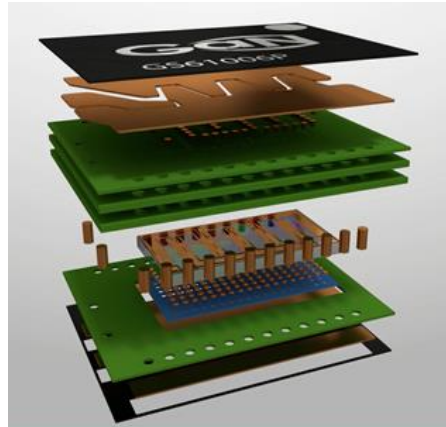

Complex eMode discrete drive

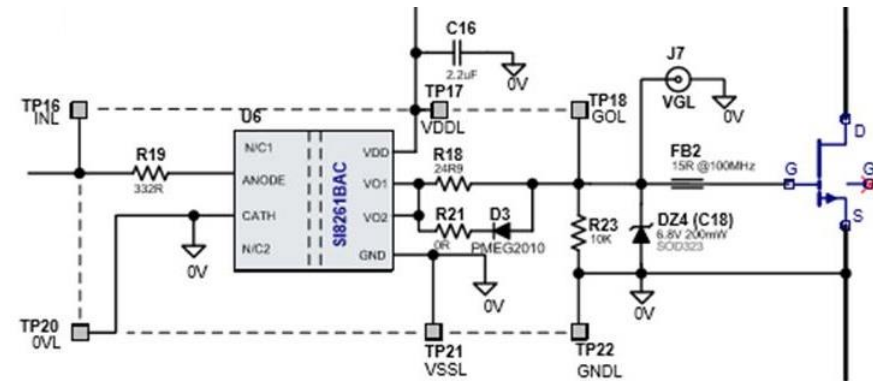

From GS66508T-EVBHB 650V GaN E-HEMT Half Bridge Evaluation Board

Switch, Drive:

# Creating the World's First AllGaN™ Power ICs

Fastest, most efficient  
GaN Power FETs

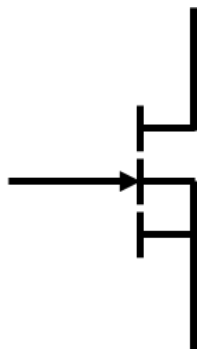

First & Fastest  
Integrated GaN Gate Driver

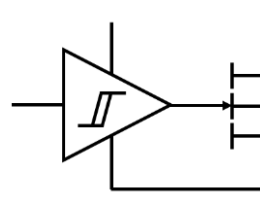

World's First  
AllGaN™ Power IC

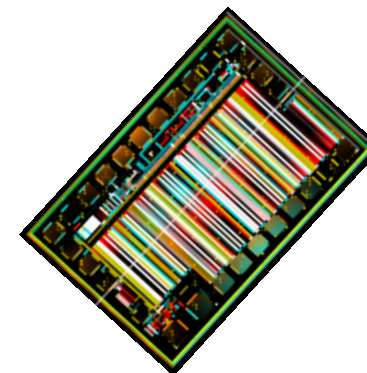

Up to 40MHz switching, 4x higher density & 20% lower system cost

Switch, Drive:

# Navitas GaN Power IC

- Monolithic integration
- 20x lower drive loss than silicon
- Driver impedance matched to power device
- Shorter prop delay than silicon (10ns)
- Zero inductance turn-off loop
- Digital input (hysteretic)
- Rail-rail drive output
- Layout insensitive

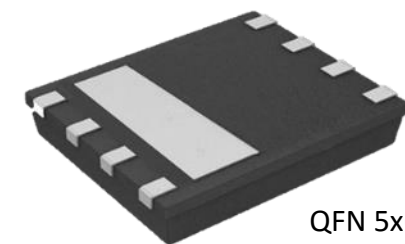
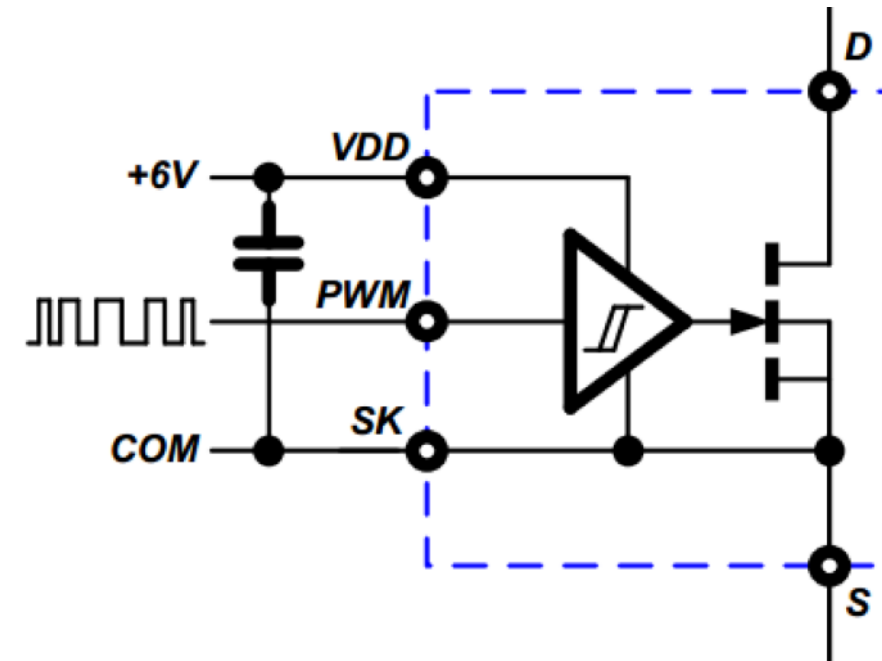

QFN 5x6mm

Package:

# Fast, Low Cost, Industry-Standard QFN

- Leadframe-based 5x6mm power package outline
- Low profile, small footprint with HV clearance
- Kelvin source connection for gate drive return
- Low inductance power connections ( $\sim 0.2\text{nH}$ )
- Low thermal resistance ( $< 2^\circ\text{C/W}$ )
- I/O pins enough for drive functions
- High volume, reliable, low cost

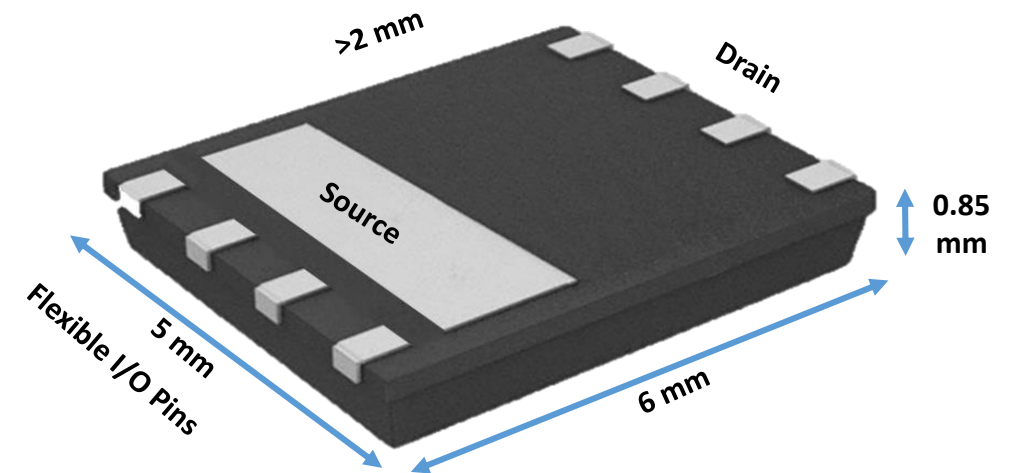

Monolithic Drive:

# Crisp & Efficient Gate Control

- Eliminates gate overshoot and undershoot
- Zero inductance on chip insures no turn-off loss

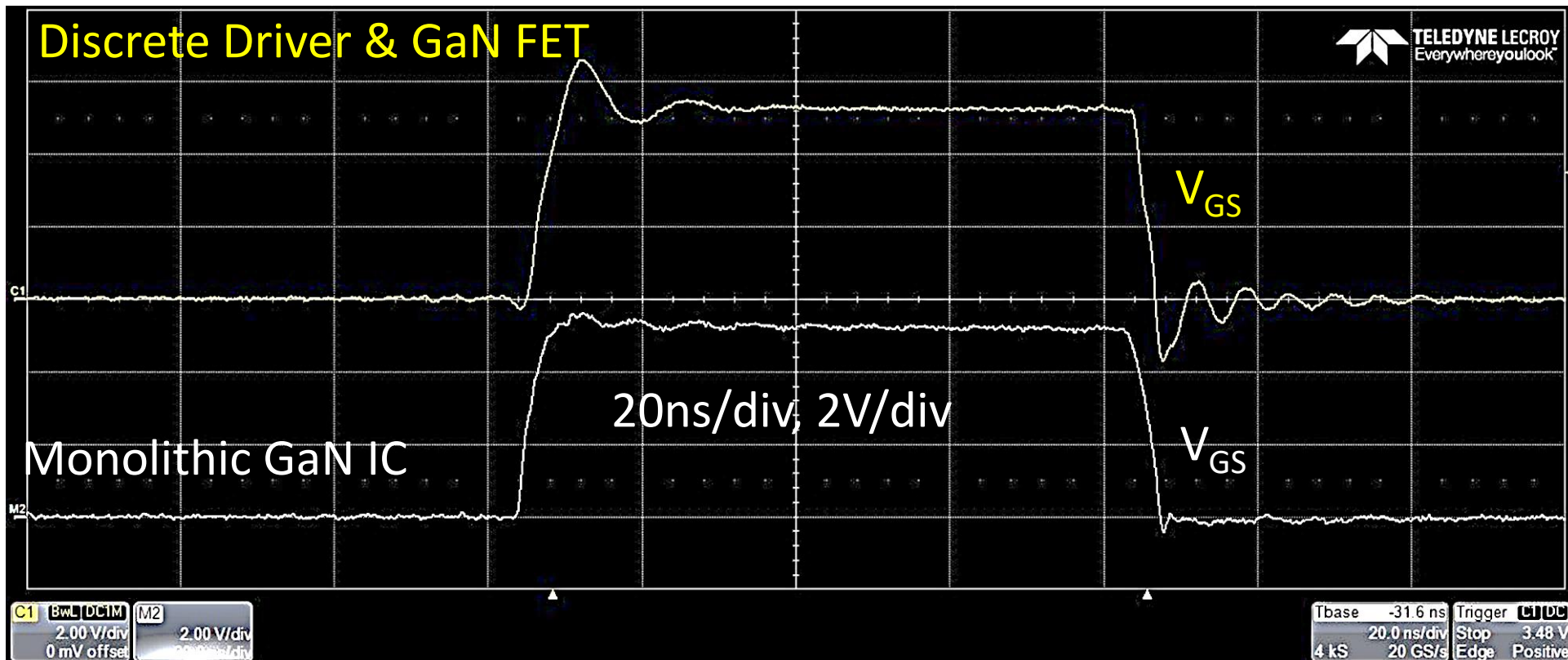

# Hard-Switch

*Primary Switch Power Loss:*

$$P_{FET} = P_{COND} + P_{DIODE} + P_{T-ON} + P_{T-OFF} + P_{DR} + P_{QRR} + P_{QOSS}$$

Topology:

# Hard-Switch → Soft-Switch

*Primary Switch Power Loss:*

$$P_{FET} = P_{COND} * k + P_{DIODE} + P_{T-ON} + P_{T-OFF} + P_{DR} + P_{QRR} + P_{QOSS}$$

- k-factor >1 due to increased circulating current, duty cycle loss
- $P_{T-On}$  = 0 (soft-switch)
- $P_{Qoss}$  ↓2-3x (silicon devices can have high  $C_{OSS}$  charging/discharging losses)

Topology:

# Hard-Switch → Soft-Switch with eMode GaN

*Primary Switch Power Loss:*

$$P_{FET} = P_{COND} \overset{\text{Minimized}}{* k} + \overset{\text{Reduced}}{P_{DIODE}} + P_{T-ON} + P_{T-OFF} + P_{DR} + P_{QRR} + P_{QOSS}$$

- k-factor >1 due to increased circulating current, duty cycle loss
- $P_{T-On}$  = 0 (soft-switch)
- $P_{Qoss}$  ↓ 10x ~~2-3x~~ (GaN  $C_{OSS}$  charging/discharging loss negligible up to 2MHz)
- $P_{DRIVER}$  ↓ 10x (GaN  $P_{DR}$  negligible up to 2MHz)
- $P_{QRR}$  = 0
- $P_{DIODE}$  ↓ 2x (reverse conduction loss reduced by synchronous rectification)
- $P_{T-OFF}$  = Reduced (limited by I-V crossover loss due to drive loop impedance)



# Hard-Switch → Soft-Switch with GaN Power IC

## Primary Switch Power Loss:

$$P_{FET} = P_{COND} * k + P_{DIODE} + P_{T-ON} + P_{T-OFF} + P_{DR} + P_{QRR} + P_{QOSS}$$

Minimized Minimized  
\* k + P<sub>DIODE</sub>

- k-factor >1 due to increased circulating current, duty cycle loss
- $P_{T-On}$  = 0 (soft-switch)
- $P_{Qoss}$  ↓ 10x ~~2-3x~~ (GaN  $C_{OSS}$  charging/discharging loss negligible up to 2MHz)
- $P_{DRIVER}$  ↓ 10x (GaN  $P_{DR}$  negligible up to 2MHz)
- $P_{QRR}$  = 0
- $P_{DIODE}$  ↓ 3x ~~2x~~ (synchronous rectification with improved dead-time control)
- $P_{T-OFF}$  = 0 ~~Reduced~~ (near-zero drive loop impedance with integration)

**>10x frequency increase possible with higher efficiencies**

# MHz Controllers ... with more, faster to come



## PFC (BCM):

- L6562 (1MHz)
- NCP1608 (1MHz)
- UCC28061 (500kHz)



## DC-DC (LLC):

- NCP1395 (1.2MHz)
- FAN7688 (500kHz) (+SR)
- ICE2HS01G (1MHz)



## DC-DC (Sync Rectifier):

- NCP4305 (1MHz)
- UCC24610 (600kHz)

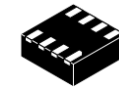

## PWM:

- NCP1252 (500kHz)
- NCP1565 (1.5MHz)
- UCC28C44 (1MHz)
- UCC25705 (4MHz)

## DSP

- UCD3138 (2MHz)
- dsPIC33xx (5MHz)
- ADP1055 (1MHz)



Switch:

# SR FETs: Better with GaN

- All relevant FsOM favor GaN at 60V
  - $R_{DS(ON)} \times Q_G$  reflects drive losses
  - $R_{DS(ON)} \times Q_{OSS}$  reflects turn-off losses with non-resonant rectification
  - $R_{DS(ON)} \times Q_{RR}$  reflects stored minority carrier turn-off losses (minimized with dead-time control)
- Si in QFN 5x6mm, GaN is Chip-Scale BGA

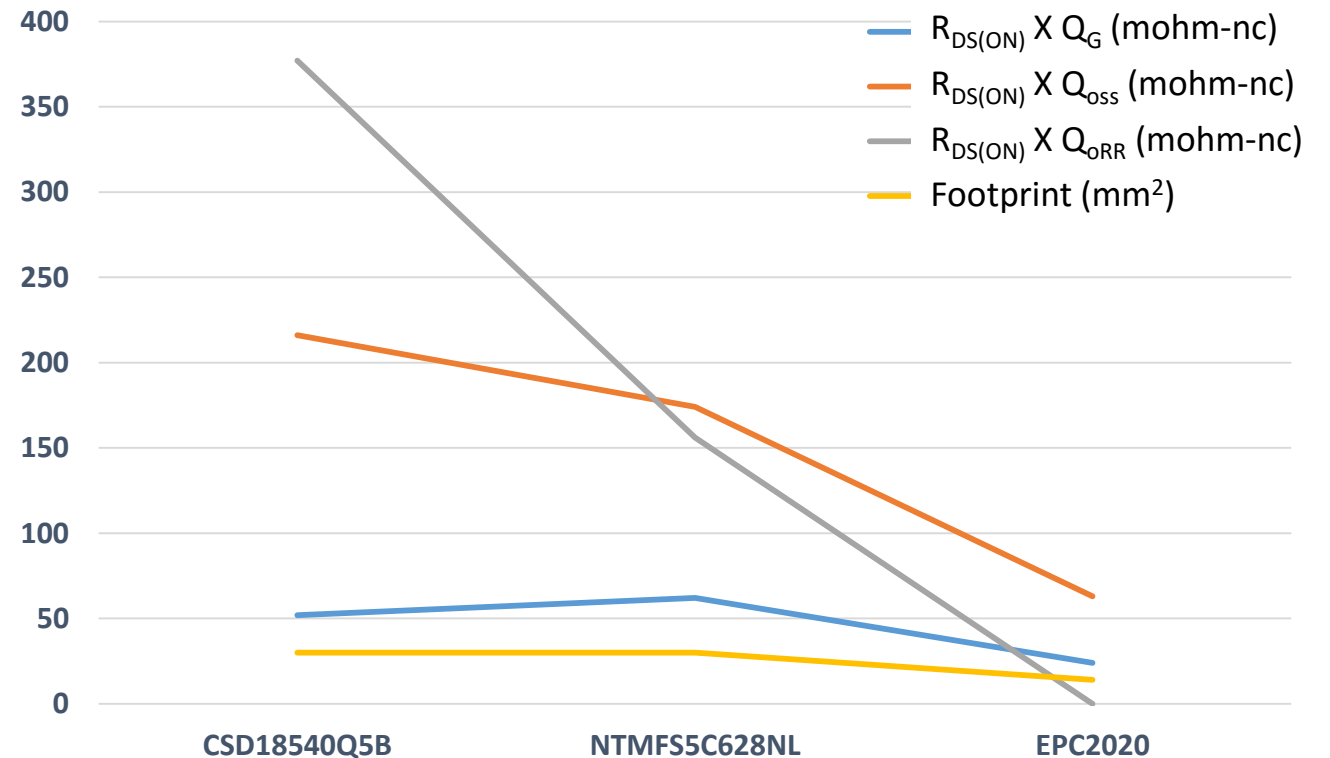

# Smooth, clean, controlled waveforms

- 500V Switching
- No overshoot / spike
- No oscillations
- 'S-curve' transitions
- ZVS Turn-on
- Zero loss turn-off
- Sync rectification
- High frequency
- Small, low cost filter

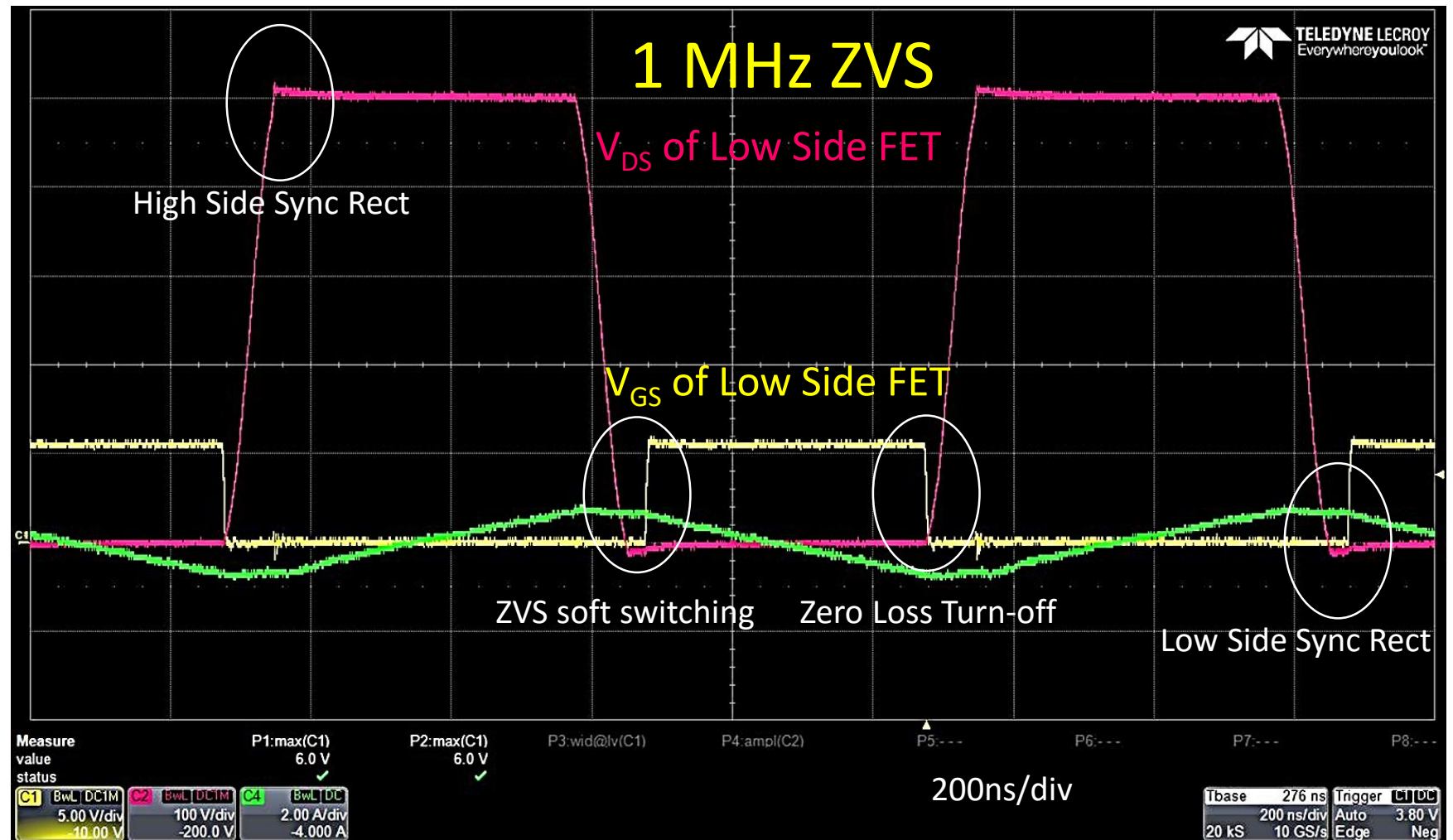

Topology:

# Critical Conduction Mode (CrCM) PFC

- CrCM PFC enables ZVS / QR operation
  - Also known as Boundary Conduction Mode (BCM)
  - Ideal for high frequency
  - Uses slower, lower cost diode than in Continuous Conduction Mode (CCM)
  - Peak current 'OK' up to ~300W per phase (can interleave for higher power)
- Operating frequency varies with:
  - AC input voltage, output power, AC line cycle
- 'Nominal' frequency specified as:
  - $220V_{AC}$ , full load, peak of the AC line

# PFC Frequency vs. Power

- Calculated CrCM example to show frequency trend
- 150W PFC Boost
  - Assume L6562 controller
  - Nominal frequency = 270kHz (220V<sub>AC</sub>, full load, peak of the AC ine)
  - Maximum frequency = 1MHz (controller limit)

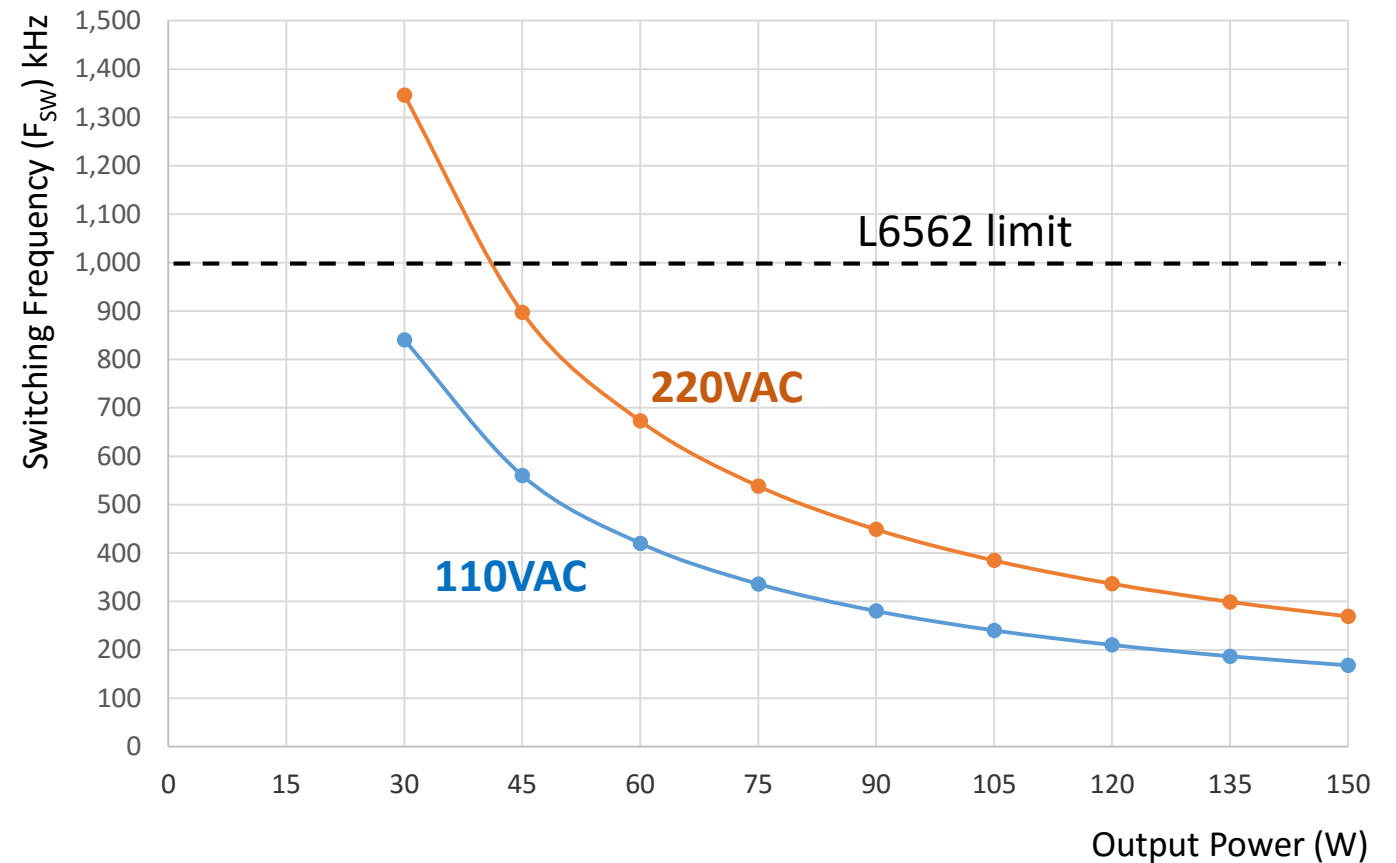

# 150W CrCM Boost PFC

- Input : Universal AC (85-265V<sub>AC</sub>, 47-63Hz)
- Output : 400V, 0.27A (150W)
- Frequency\* : 120V = 167-230kHz  
: 220V = 230-500kHz  
: 265V = 1MHz
- \*limited by control IC (L6562A)
- Efficiency : >98% peak, >97.1% average (25%, 50%, 75%, 100% load)
- Power Factor : >0.995
- Demo Size : 100 x 50 x 20mm *“No heatsink”* design
- Construction : 2-layer PCB, SMT powertrain on bottom side

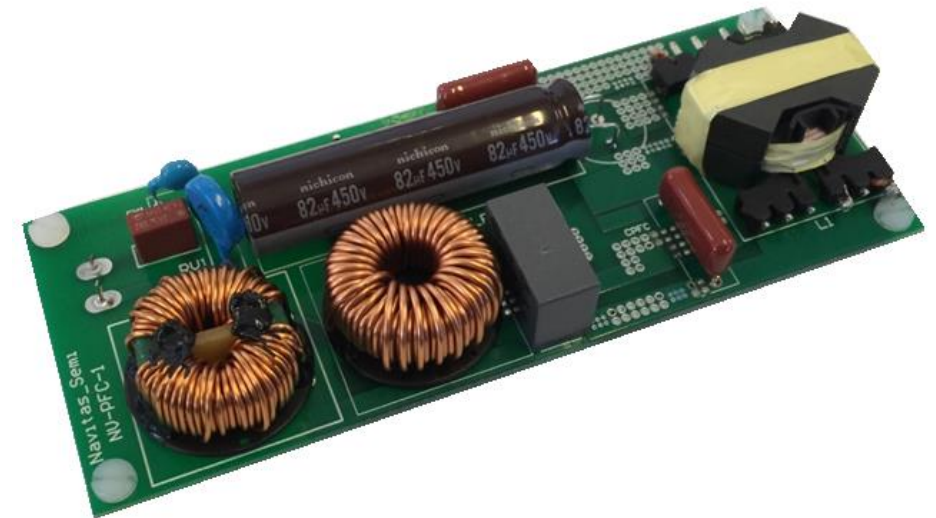
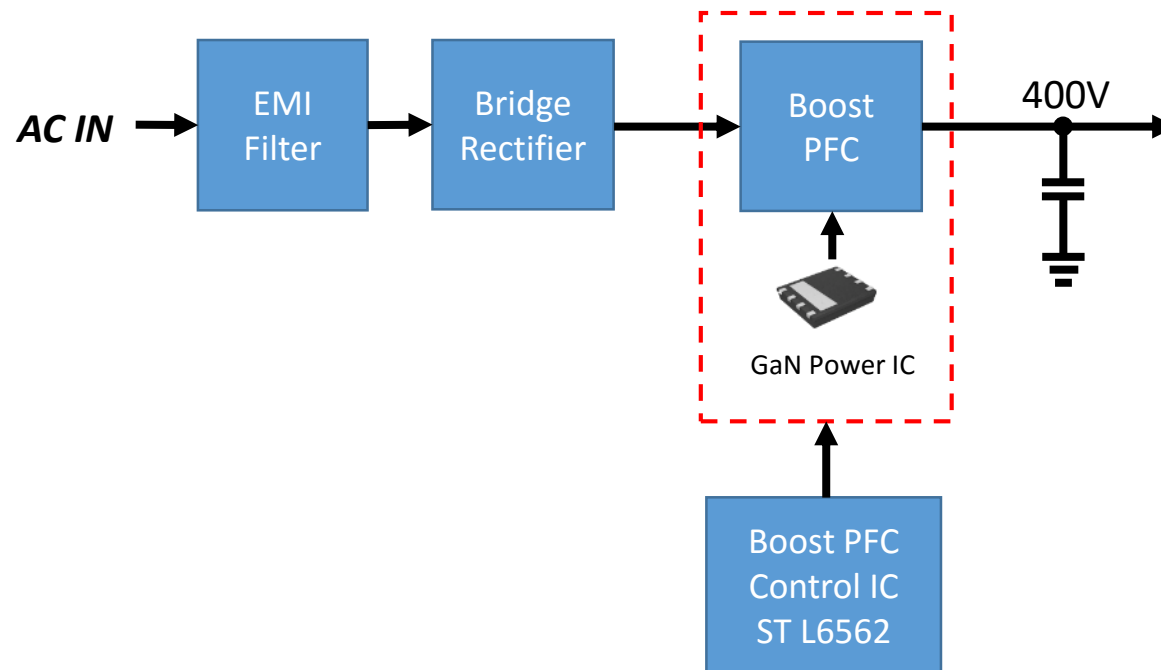

# 150W PFC: Schematic

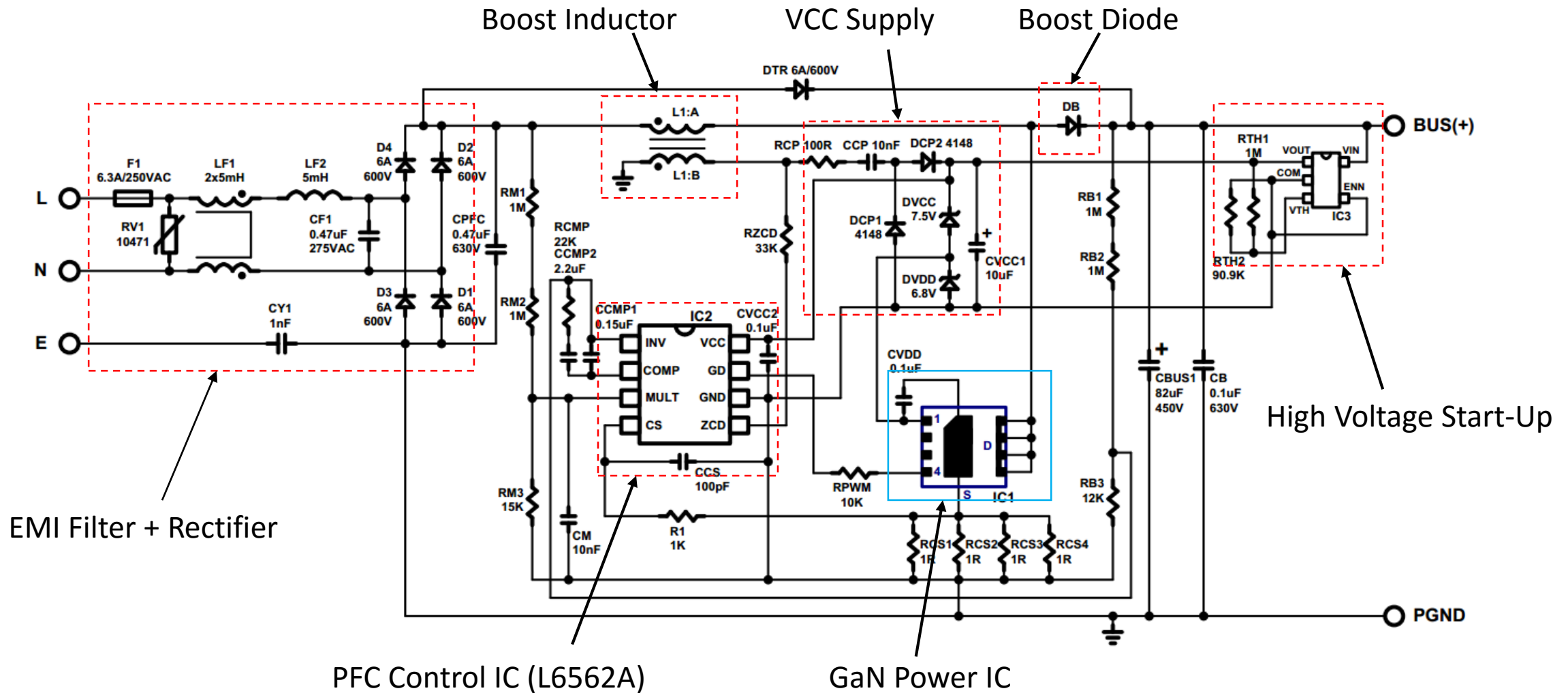



# 150W PFC: Layout

- All active semiconductors on bottom-side
  - Low profile
  - 'No-heatsink' design
- 100 x 50 x 20mm

**Bulk Cap**

**EMI Filter**

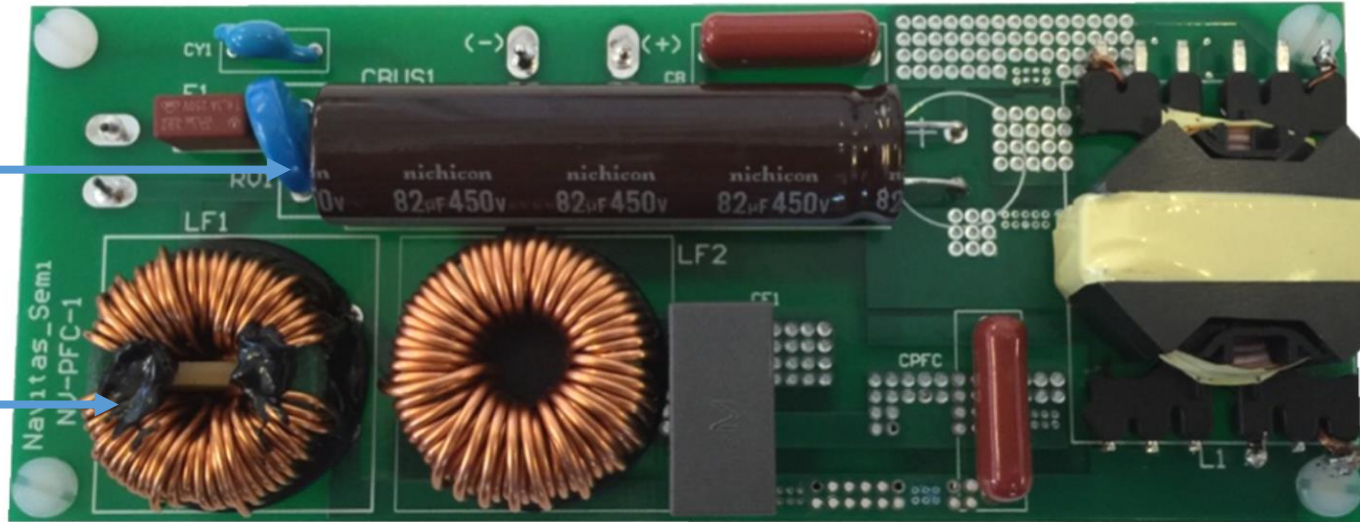

Top side

**PFC Boost Diode**

**GaN Power IC**

**L6562A PFC Control IC**

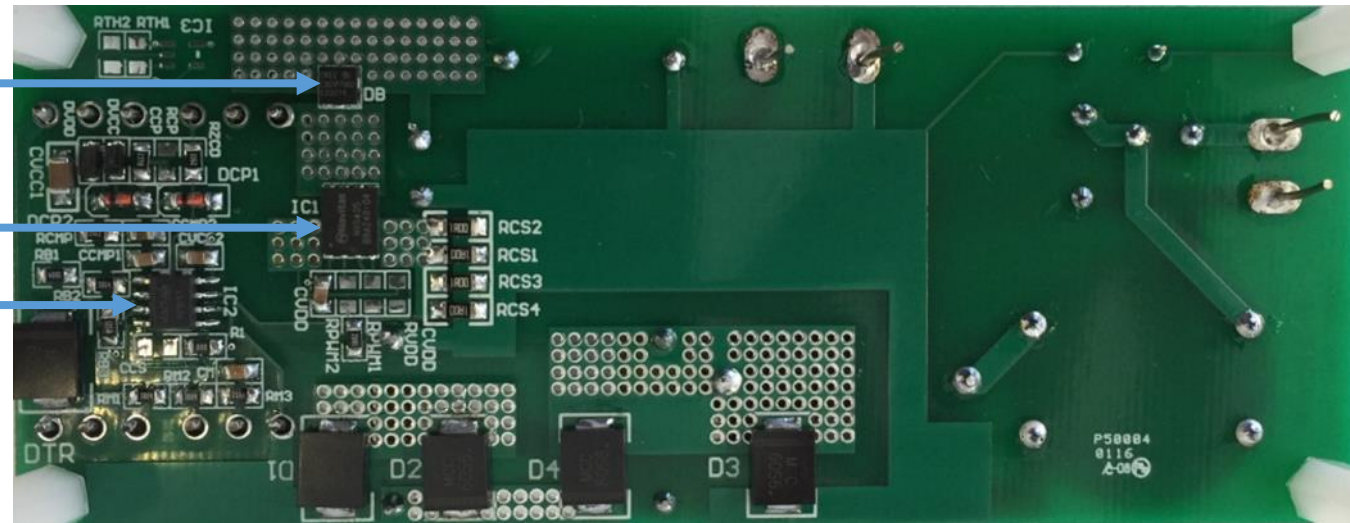

Bottom side

**AC Bridge Rectifier**

150W PFC:

# SuperJunction Si vs. GaN Power IC

	Pack	$R_{DS(ON)}$ m $\Omega$	$Q_G$ nC	$C_{OSS(er)}$ pF	$C_{OSS(tr)}$ pF	$R*Q_G$ m $\Omega$ .nC	$R*C_{OSS(tr)}$ m $\Omega$ .pF	$R*C_{OSS(er)}$ m $\Omega$ .pF
Navitas	5x6	160	2.5	30	50	400	8,000	4,800
IPL65R199CP	8x8	180	32	69	180	5,760	32,400	12,400
IPL60R130C7	8x8	115	35	53	579	4,025	66,600	6,100
<b>GaN Benefits</b>	<b>&gt;50%</b>	<b>n/a</b>	<b>&gt;10x</b>	<b>&gt;2x</b>	<b>&gt;10x</b>	<b>&gt;10x</b>	<b>&gt;7x</b>	<b>&gt;2.5x</b>

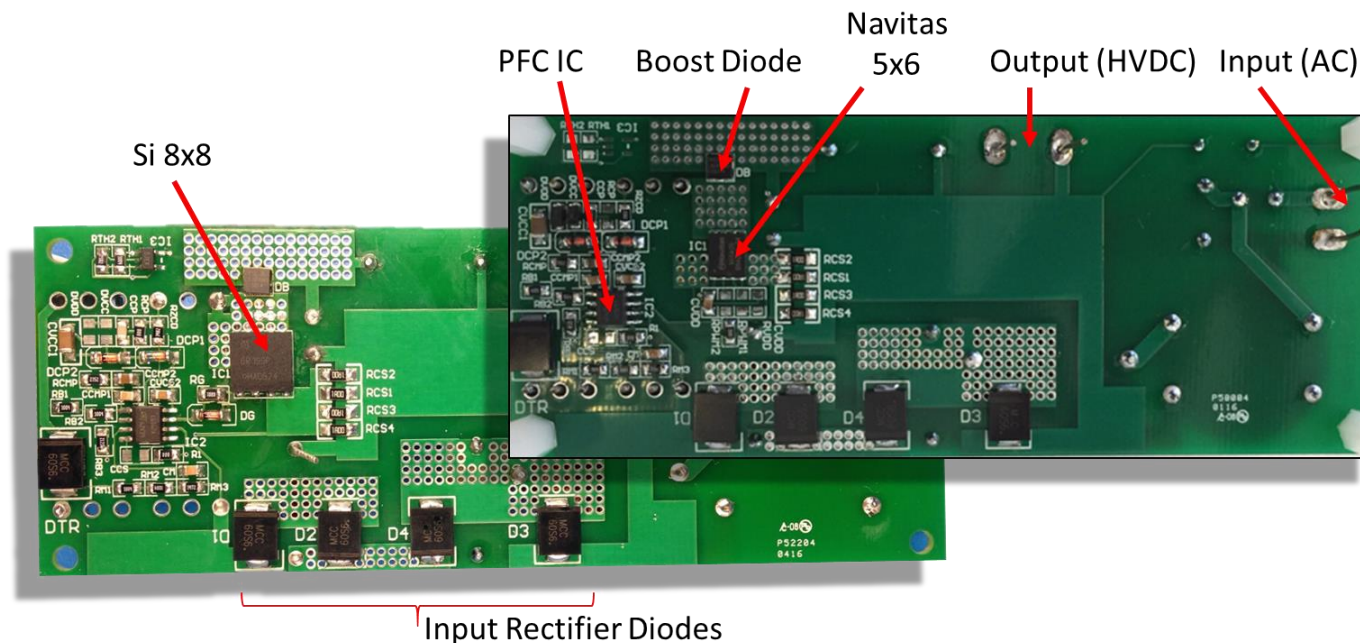

# Full Load FET Temperature

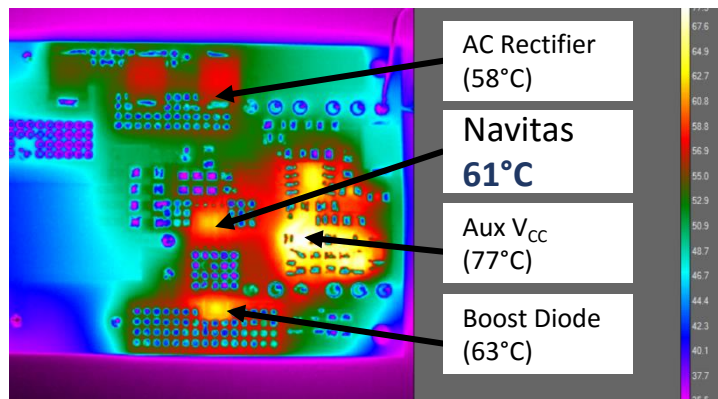

220V<sub>AC</sub>, 150W

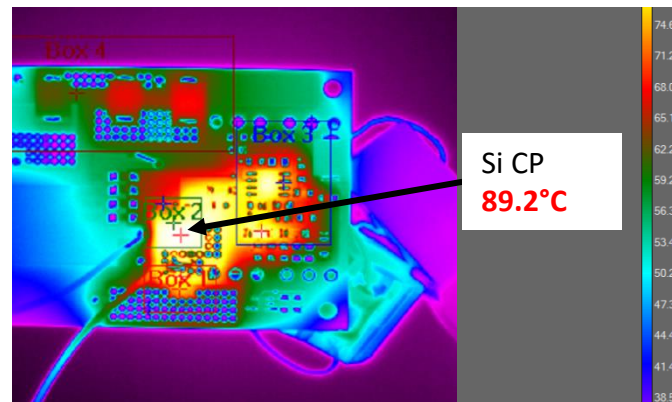

220V<sub>AC</sub>, 150W

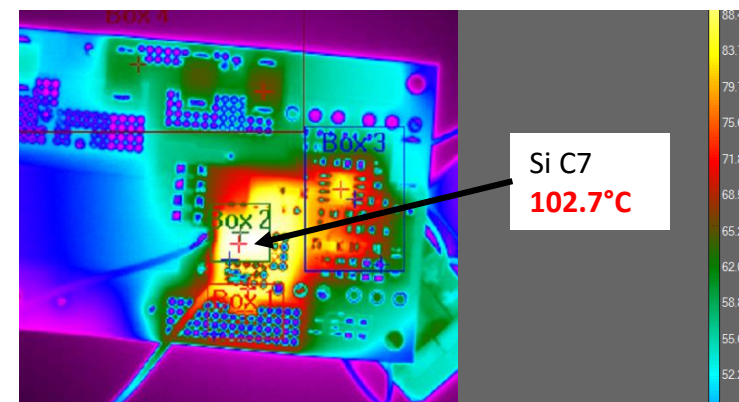

180V<sub>AC</sub>, 150W

- GaN running cool (61°C)
  - Efficiency up 1% vs. Si CP
  - Loss 20-35% lower
  - Power Factor >99.5%

- CP Si running >90°C
- C7 Si too hot to run at 220V<sub>AC</sub>

# Silicon's High $C_{OSS}$ Creates Partial ZVS

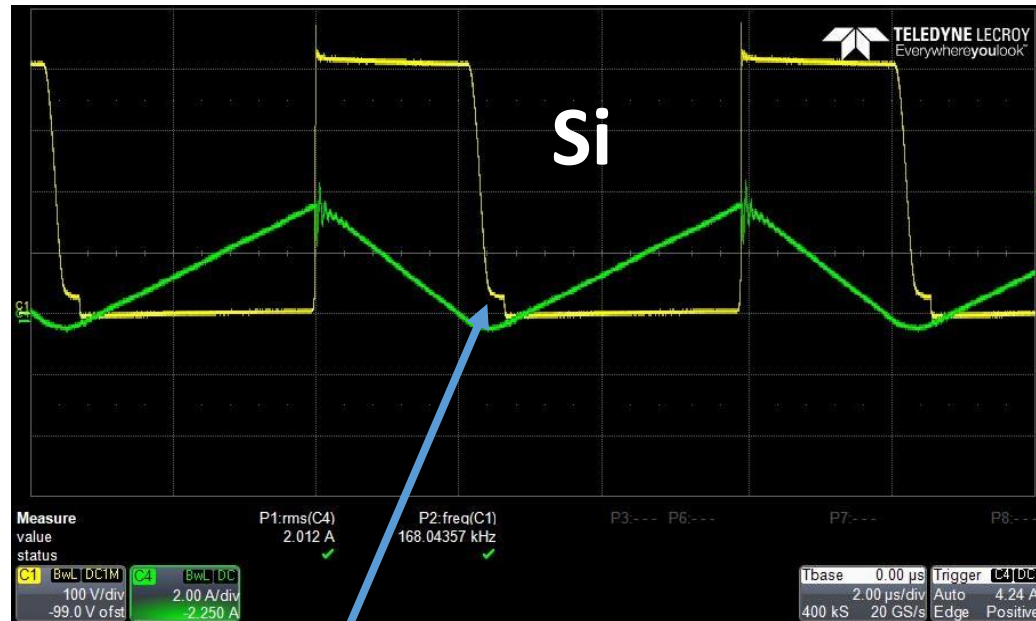

120V<sub>AC</sub>, Si CP partial hard-switching (~200kHz)

- High loss due to large stored charge while hard-switching
- Si  $C_{OSS}$  is 50x-100x worse than GaN at  $V_{DS} < 30V$

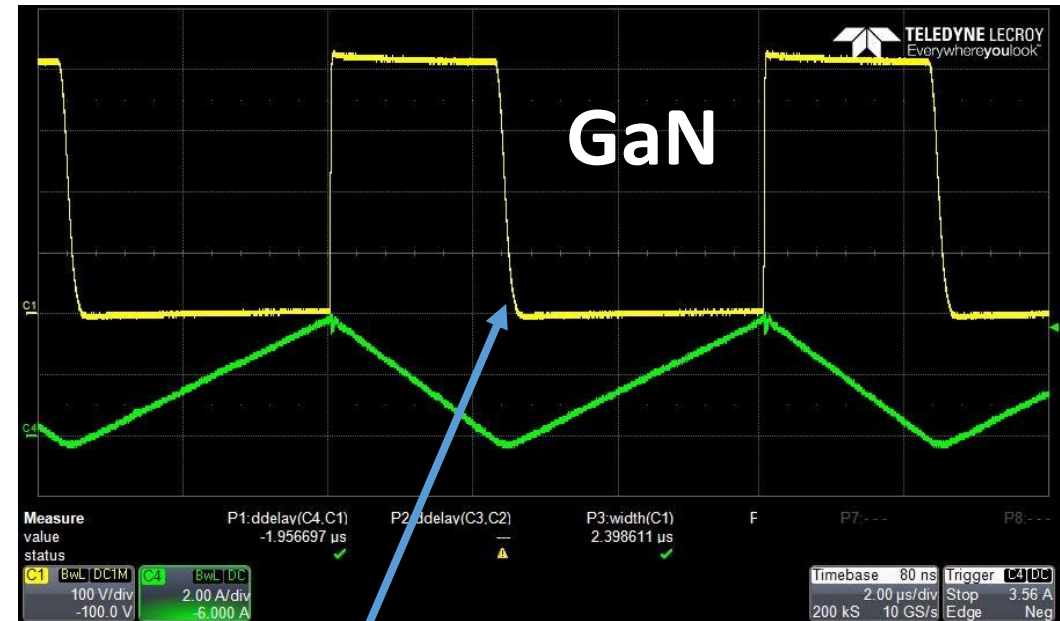

120V<sub>AC</sub>, GaN clean ZVS waveforms (~200kHz)

- Turn-off losses low due to integrated drive
- Near loss-less ZVS turn-on transition
- Minimize deadtime for low reverse conduction loss
- No voltage spikes / overshoot

# Critical Parameters: $C_{OSS}$ , $E_{OSS}$

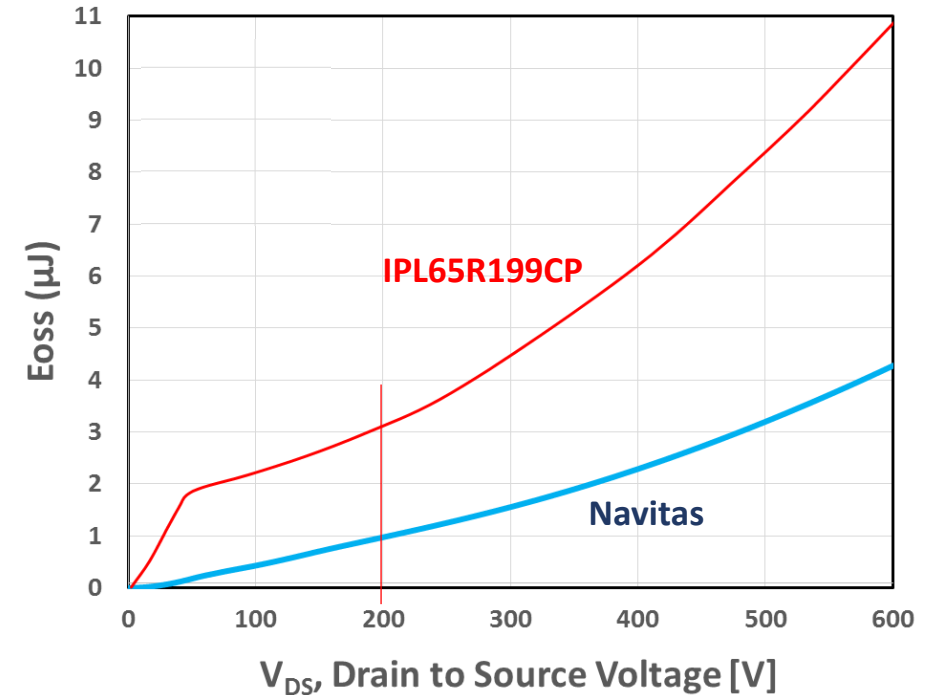
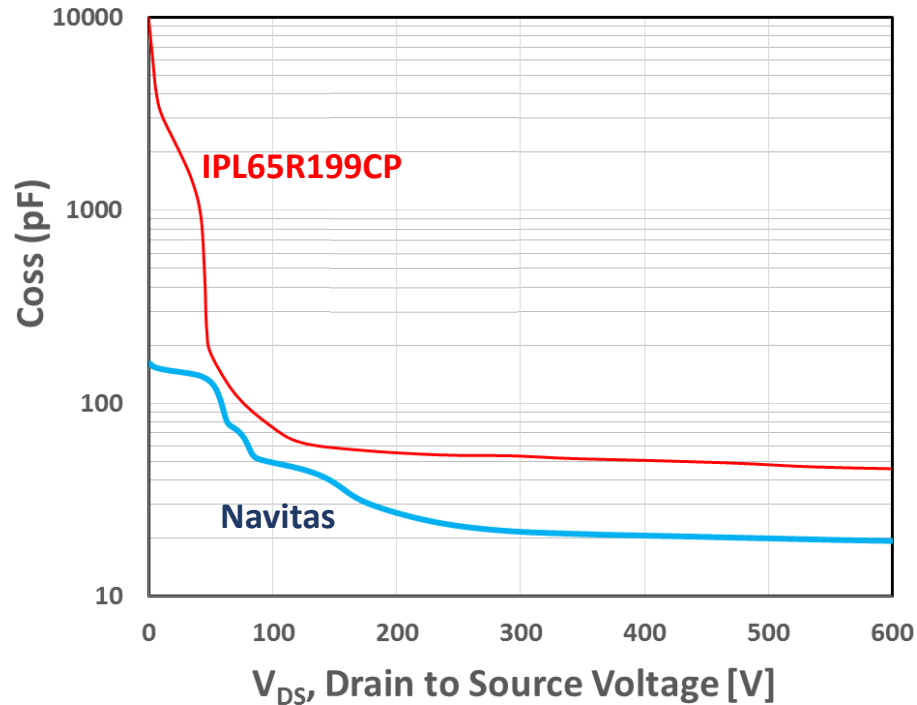

- $Q_{OSS}$  charge affects ZVS transition time and  $E_{OSS}$  under partial ZVS condition
- Switching loss:  $P_{LOSS} = E_{OSS} (V_{DS}) * F_{SW}$ 
  - Si has 3x higher loss than GaN at 200V (partial ZVS) - big effect at full or light load condition
  - CrCM boost has inherent partial ZVS at high line – so 265VAC and light load is worst case
- For more information: “ $C_{OSS}$  Hysteresis in Advanced Superjunction MOSFETs”, Harrison, APEC 2016

# Long Si ZVS Transition Time = Trapped Energy

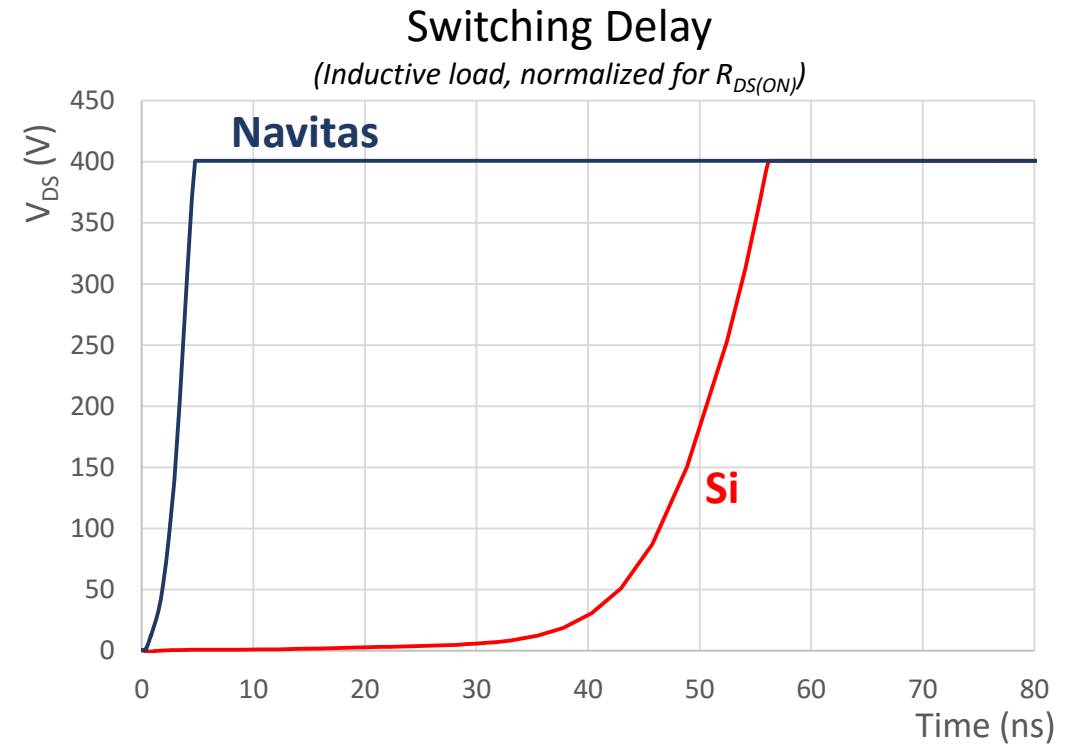
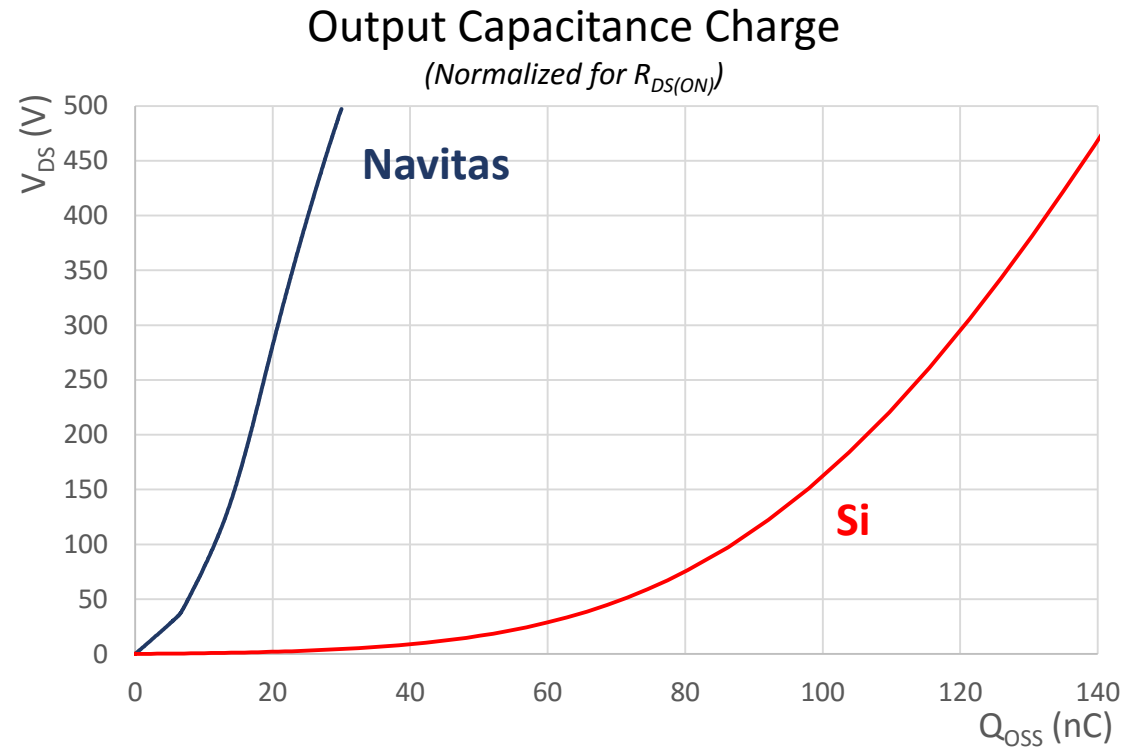

- $Q_{OSS}$  directly proportional to transition time, which limits max frequency
- If too slow, goes into partial ZVS condition, creates  $E_{OSS}$  loss

# Light Load = High Frequency = High Loss for Si

Switching loss:  $P_{LOSS}$

$$= E_{OSS} (V_{DS}) * \text{frequency (at 20W)}$$

$$= 3.5\mu\text{J} * 455\text{kHz}$$

$$= 1.59\text{W}$$



$$= 160^{\circ}\text{C} !$$

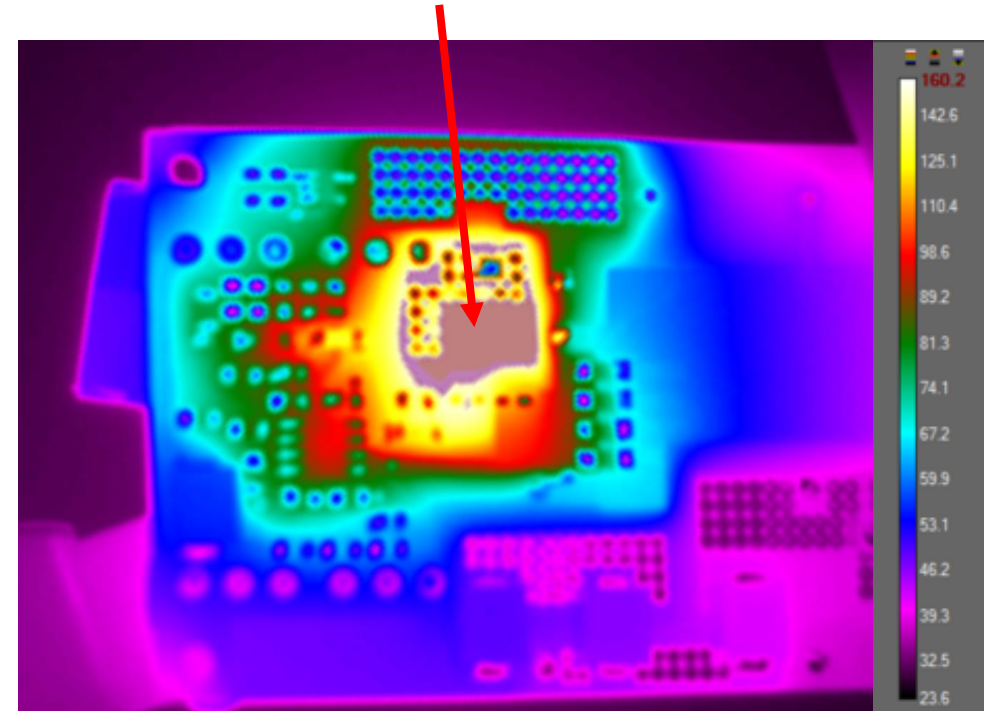
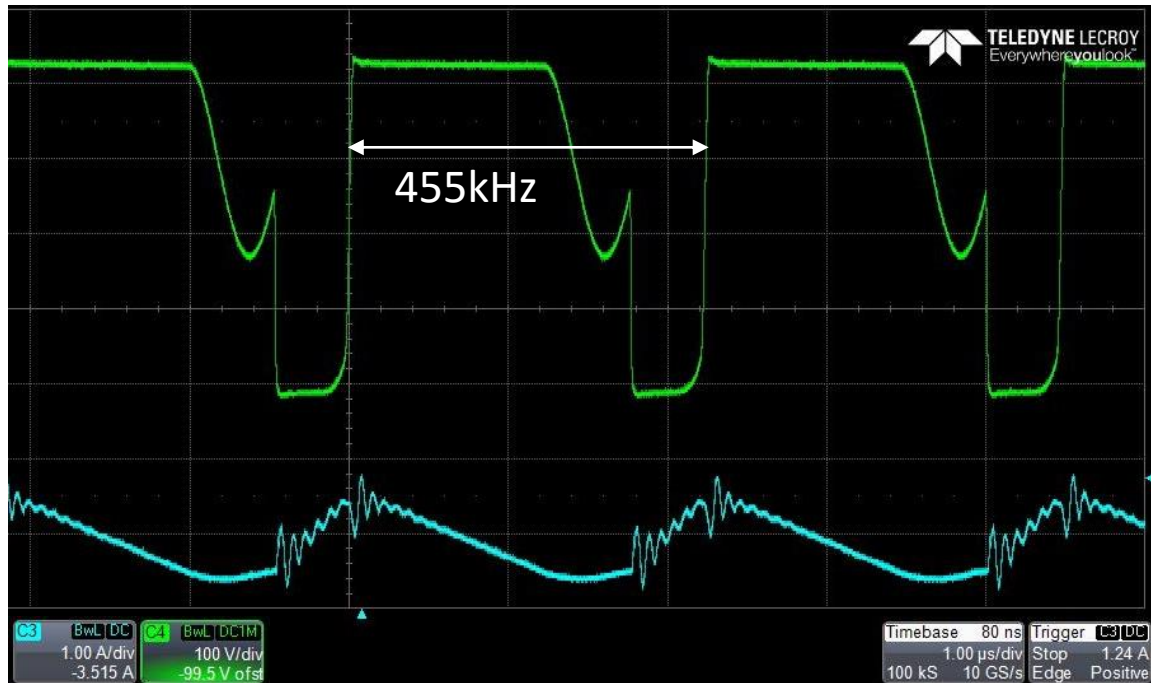

Light-Load = High Frequency

# Hot Si, Cool GaN

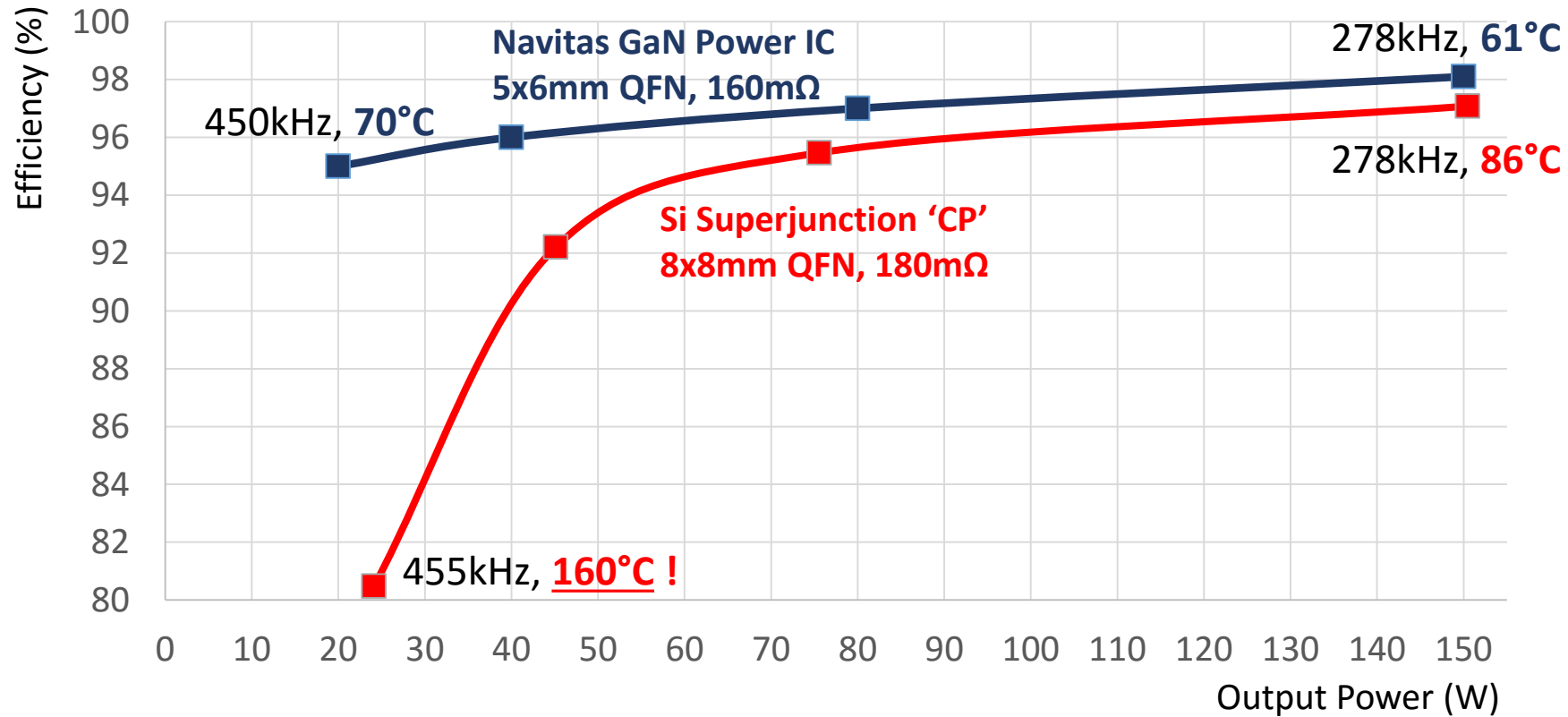



Topology:

# LLC at 650kHz (400-12V)

$V_{SW}$  (100V/div)

$I_L$  (1A/div)

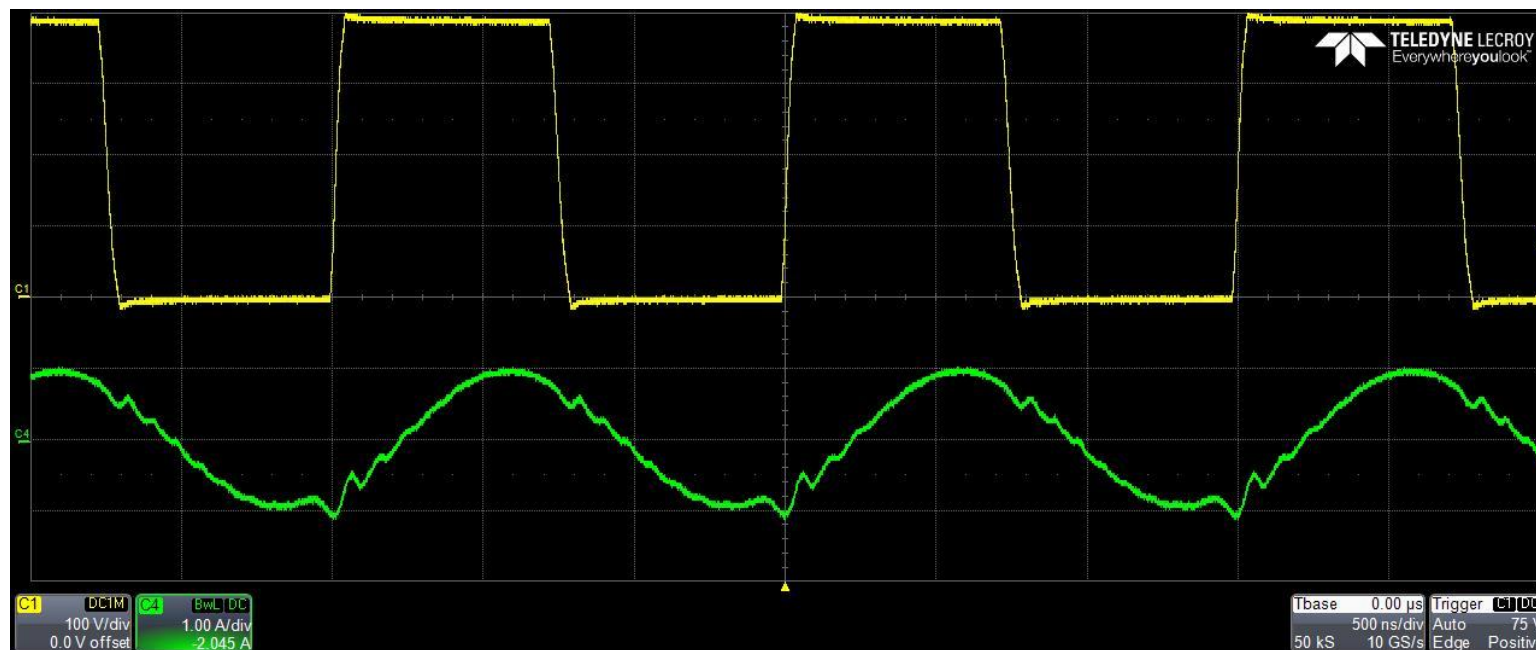

Normal Operation, 50% duty cycle, Full ZVS

# Topology: PFC+LLC

## Frequency drives 2x-4x Power Density

- Typical adapters (65-150kHz) = 5-12W/in<sup>3</sup>
- Navitas demo (500kHz) = 13.5W/in<sup>3</sup>
- Navitas customer estimate = 20-25W/in<sup>3</sup>

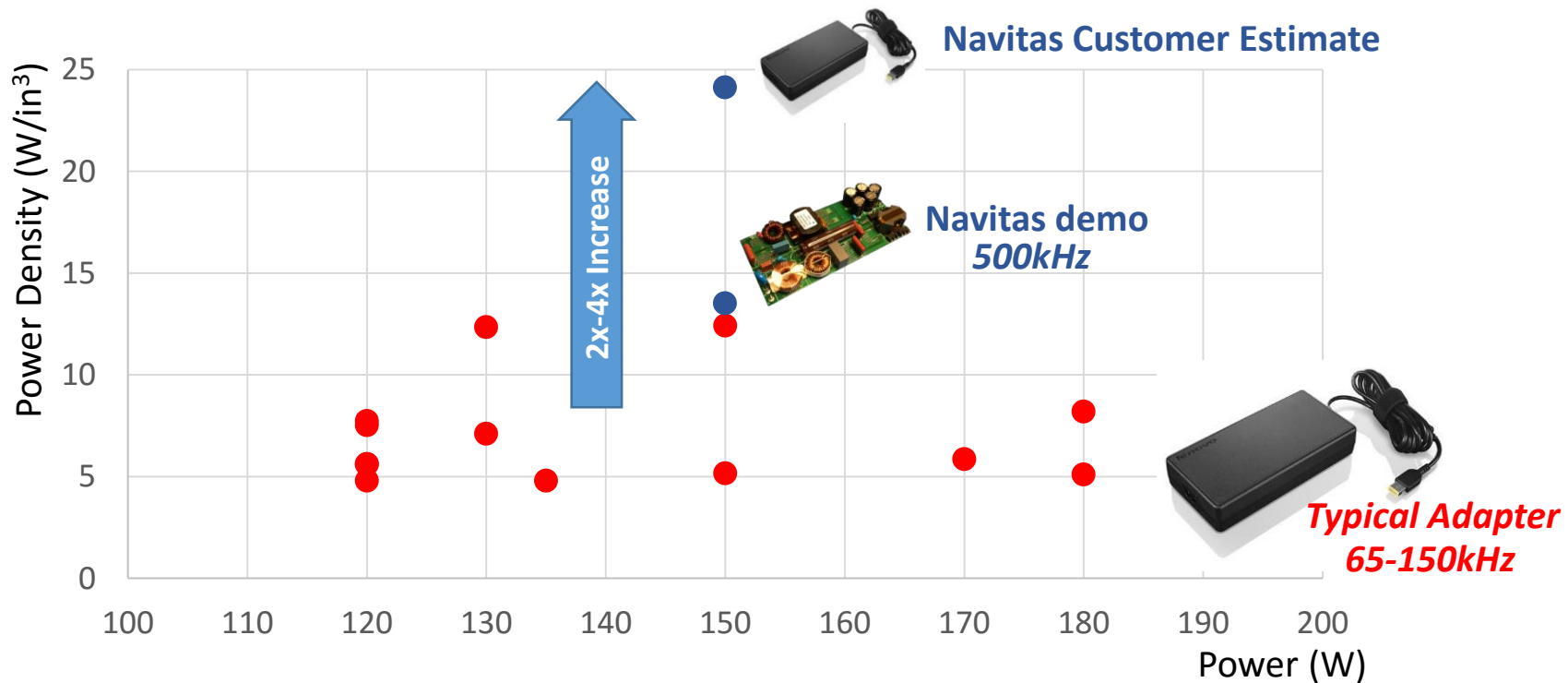

Gamer Laptops (100-150W)



All-in-One PCs (150-200W)



38"-52" TVs (100-200W)

# I found my Eco-System!

