

650 V 28.5 mΩ SiC MOSFET

Silicon Carbide MOSFET

Trench-Assisted Planar Technology

V _{DS}	=	650 V
R _{DS(ON)(Typ.)}	=	28.5 mΩ
I _D (T _C = 100°C)	=	56 A

Features

- Gen3F (3rd Generation) Technology
- Most Stable R_{DS(ON)} over Temperature
- Low C_{OSS}, C_{RSS} and Balanced C_{ISS}/C_{RSS}
- Lower Q_{GD} and Balanced R_{G(INT)}
- Electromagnetically Optimized Design
- Robust Body Diode with Low V_F and Low Q_{RR}
- Superior Cost-Performance Index
- AEC-Q101 Qual in Progress and PPAP Capable

Package

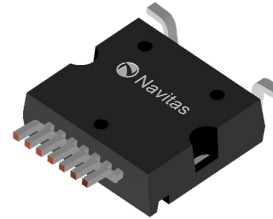

HV-T2PAK

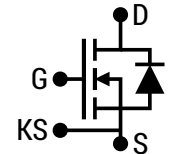

D = Drain (8-9, Tab)
 G = Gate (1)
 S = Source (3-7)
 KS = Kelvin Source (2)



Advantages

- Leading Performance and Robustness
- Lowest Conduction Losses at all Temperatures
- Lesser Switching Spikes and Lower Losses
- Faster and More Efficient Switching
- Reduced Ringing
- Ease of Paralleling without Thermal Runaway
- Excellent Power Density and System Efficiency
- Enhanced System Reliability

Applications

- xEV - OBC & DC-DC
- EV Fast Charging Infrastructure
- Solar / PV
- Energy Storage System
- Server & Telecom Power Supply
- Uninterruptible Power Supply
- Motor Control
- Class D Amplifiers

Absolute Maximum Ratings (At T_C = 25°C Unless Otherwise Stated)

Parameter	Symbol	Conditions	Values	Unit	Note
Drain-Source Voltage	V _{DS(max)}	V _{GS} = 0 V, I _D = 100 μA	650	V	
Gate-Source Voltage (Dynamic)	V _{GS(max)}		-10 / +22	V	
Gate-Source Voltage (Static)	V _{GS(op)-ON}	Recommended Operation	15 to 18	V	Note 1
	V _{GS(op)-OFF}		-5 to -3		
Continuous Drain Current	I _D	T _C = 25°C, V _{GS} = -5 / +18 V	80	A	Fig. 16
		T _C = 100°C, V _{GS} = -5 / +18 V	56		
		T _C = 135°C, V _{GS} = -5 / +18 V	41		
Pulsed Drain Current	I _{D(pulse)}	t _p ≤ 3μs, D ≤ 1%, V _{GS} = 18 V	130	A	Note 2
Power Dissipation	P _D	T _C = 25°C	261	W	Fig. 17
Non-Repetitive Avalanche Energy	E _{AS}	L = 36 mH, I _{AV} = 4 A	288	mJ	
Operating Junction and Storage Temperature	T _j , T _{stg}		-55 to 175	°C	

Note 1: This product can support 0V turn-off gate drive voltage with optimized PCB layout and gate drive circuit configuration.

Note 2: Pulse Width t_p Limited by T_{j(max)}

NOTE: This datasheet provides preliminary specifications. Parameters, conditions and values are subject to change.

Electrical Characteristics (At $T_C = 25^\circ\text{C}$ Unless Otherwise Stated)

Parameter	Symbol	Conditions	Values			Unit	Note
			Min.	Typ.	Max.		
Drain-Source Breakdown Voltage	V_{DSS}	$V_{GS} = 0\text{ V}, I_D = 100\ \mu\text{A}$	650			V	
Zero Gate Voltage Drain Current	I_{DSS}	$V_{DS} = 650\text{ V}, V_{GS} = 0\text{ V}$		1	100	μA	
Gate Source Leakage Current	I_{GSS}	$V_{DS} = 0\text{ V}, V_{GS} = 22\text{ V}$ $V_{DS} = 0\text{ V}, V_{GS} = -10\text{ V}$			100 -100	nA	
Gate Threshold Voltage	$V_{GS(th)}$	$V_{DS} = V_{GS}, I_D = 12\text{ mA}$	2.2	2.7	4.3	V	Note 3
Transconductance	g_{fs}	$V_{DS} = 10\text{ V}, I_D = 26\text{ A}$ $V_{DS} = 10\text{ V}, I_D = 26\text{ A}, T_j = 175^\circ\text{C}$		13.3 14.4		S	Fig. 5
Drain-Source On-State Resistance	$R_{DS(on)}$	$V_{GS} = 18\text{ V}, I_D = 26\text{ A}, T_j = 175^\circ\text{C}$ $V_{GS} = 15\text{ V}, I_D = 26\text{ A}$ $V_{GS} = 15\text{ V}, I_D = 26\text{ A}, T_j = 175^\circ\text{C}$		28.5 40 38 46	38	m Ω	Fig. 5-9
Input Capacitance	C_{iss}			2394			
Output Capacitance	C_{oss}			163		pF	Fig. 12
Reverse Transfer Capacitance	C_{riss}			9.3			
C_{oss} Stored Energy	E_{oss}	$V_{DS} = 400\text{ V}, V_{GS} = 0\text{ V}$ $f = 500\text{ KHz}, V_{AC} = 25\text{ mV}$		15		μJ	Fig. 13
C_{oss} Stored Charge	Q_{oss}				104		nC
Effective Output Capacitance (Energy Related)	$C_{o(er)}$			188			
Effective Output Capacitance (Time Related)	$C_{o(tr)}$			260		pF	Note 4
Gate-Source Charge	Q_{gs}	$V_{DS} = 400\text{ V}, V_{GS} = -5 / +18\text{ V}$		20			
Gate-Drain Charge	Q_{gd}	$I_D = 26\text{ A}$		23		nC	Fig. 11
Total Gate Charge	Q_g	Per JEDEC JEP-192		81			
Internal Gate Resistance	$R_{G(int)}$	$V_{GS} = 18\text{ V}, f = 1\text{ MHz}, V_{AC} = 25\text{ mV}$		1.3		Ω	
Turn-On Switching Energy (Body Diode)	E_{on}	$T_j = 25^\circ\text{C}, V_{GS} = -5/+18\text{V}, R_{G(ext)} = 4.7\ \Omega, L = 60.0\ \mu\text{H}, I_D = 26\text{ A}, V_{DD} = 400\text{ V}$		41		μJ	Fig. 24-27
Turn-Off Switching Energy (Body Diode)	E_{off}				21		
Turn-On Delay Time	$t_{d(on)}$			39			
Rise Time	t_r	$V_{DD} = 400\text{ V}, V_{GS} = -5/+18\text{V}$		12			
Turn-Off Delay Time	$t_{d(off)}$	$R_{G(ext)} = 4.7\ \Omega, L = 60.0\ \mu\text{H}, I_D = 26\text{ A}$		23		ns	Fig. 26
Fall Time	t_f	Timing relative to V_{DS} , Inductive load		11			

Note 3: Tested after applying 30ms pulse at $V_{GS} = +25\text{V}$

Note 4: $C_{o(er)}$, a lumped capacitance that gives same stored energy as C_{oss} while V_{DS} is rising from 0 to 400V.
 $C_{o(tr)}$, a lumped capacitance that gives same charging times as C_{oss} while V_{DS} is rising from 0 to 400V.

Reverse Diode Characteristics

Parameter	Symbol	Conditions	Values			Unit	Note
			Min.	Typ.	Max.		
Diode Forward Voltage	V_{SD}	$V_{GS} = -5\text{ V}, I_{SD} = 13\text{ A}$		4.3		V	Fig. 18-19
		$V_{GS} = -5\text{ V}, I_{SD} = 13\text{ A}, T_j = 175^\circ\text{C}$		3.8			
Continuous Diode Forward Current	I_S	$V_{GS} = -5\text{ V}, T_c = 25^\circ\text{C}$			42	A	
		$V_{GS} = -5\text{ V}, T_c = 100^\circ\text{C}$			25		
Diode Pulse Current	$I_{S(\text{pulse})}$	$V_{GS} = -5\text{ V}$		100		A	Note 2
Reverse Recovery Time	t_{rr}			12.5		ns	
Reverse Recovery Charge	Q_{rr}	$V_{GS} = -5\text{ V}, I_{SD} = 26\text{ A}, V_R = 400\text{ V}$ $dif/dt = 2400\text{ A}/\mu\text{s}, T_j = 25^\circ\text{C}$		130		nC	
Peak Reverse Recovery Current	I_{rm}			26		A	
Reverse Recovery Time	t_{rr}			15.5		ns	
Reverse Recovery Charge	Q_{rr}	$V_{GS} = -5\text{ V}, I_{SD} = 26\text{ A}, V_R = 400\text{ V}$ $dif/dt = 2400\text{ A}/\mu\text{s}, T_j = 175^\circ\text{C}$		250		nC	
Peak Reverse Recovery Current	I_{rm}			36		A	

Package Characteristics

Parameter	Symbol	Conditions	Values	Unit	Note
Max Thermal Resistance, Junction - Case	$R_{thJC-Max}$	Maximum	0.57	$^\circ\text{C}/\text{W}$	Fig. 14
Weight	W_T		2.45	g	
Moisture Sensitivity Level	MSL		1		
EMC Material Group			II		

Fig 1: Typical Output Characteristics ($T_j = 25^\circ\text{C}$)

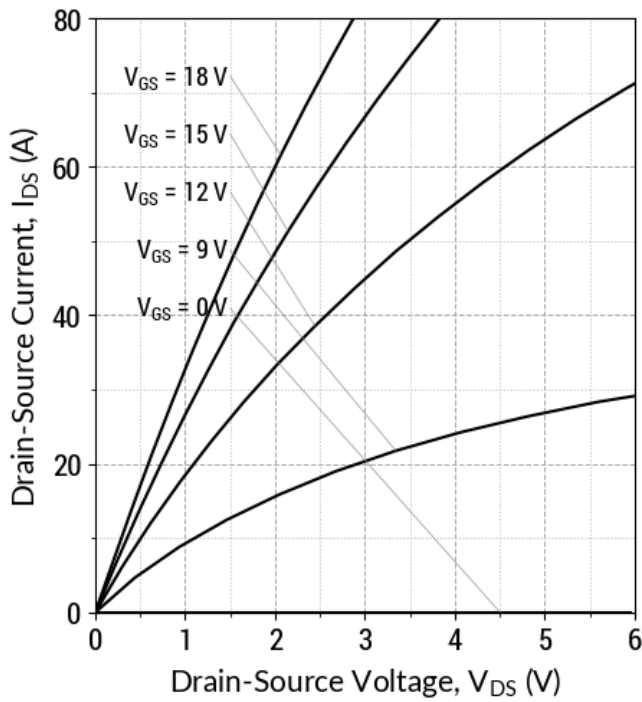

$I_D = f(V_{DS}, V_{GS}); t_P = 50 \mu\text{s}$

Fig 2: Typical Output Characteristics ($T_j = 175^\circ\text{C}$)

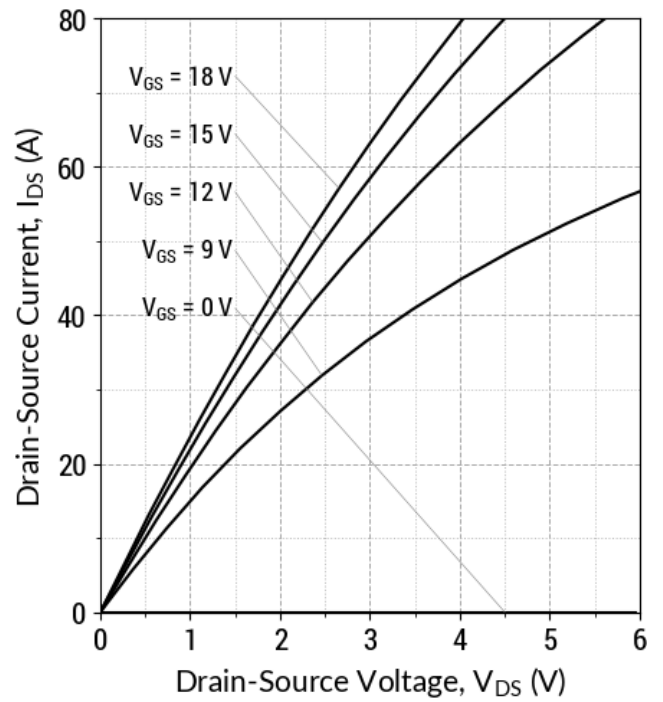

$I_D = f(V_{DS}, V_{GS}); t_P = 50 \mu\text{s}$

Fig 3: Typical Output Characteristics ($T_j = -55^\circ\text{C}$)

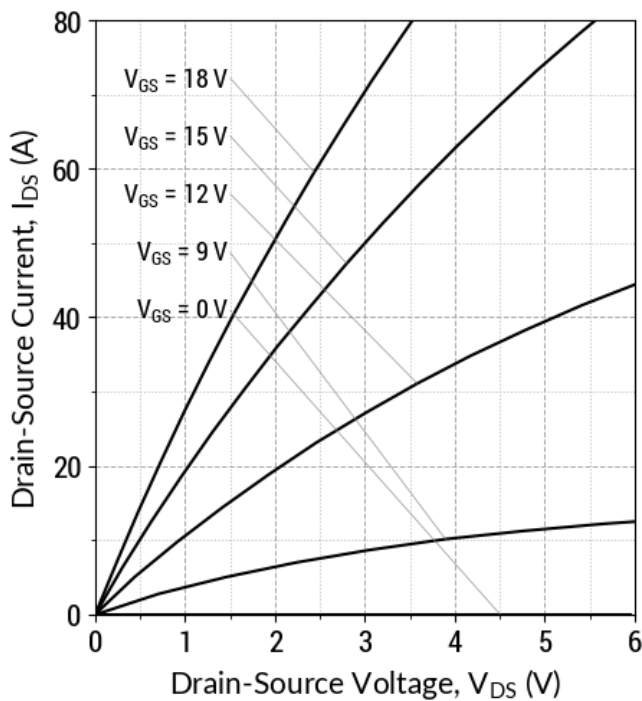

$I_D = f(V_{DS}, V_{GS}); t_P = 50 \mu\text{s}$

Fig 4: Typical Output Characteristics ($V_{GS} = 18\text{V}$)

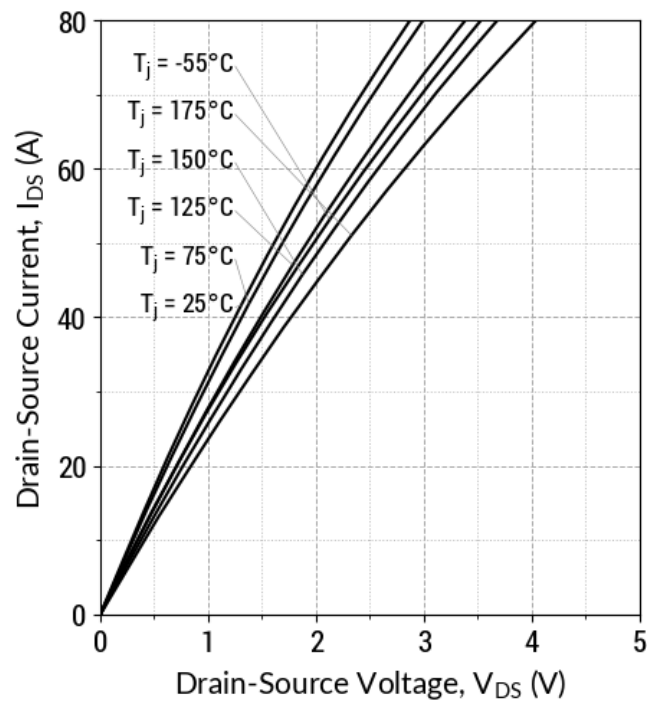

$I_D = f(V_{DS}, T_j); t_P = 50 \mu\text{s}$

Fig 5: Typical Transfer Characteristics ($V_{DS} = 10\text{ V}$)

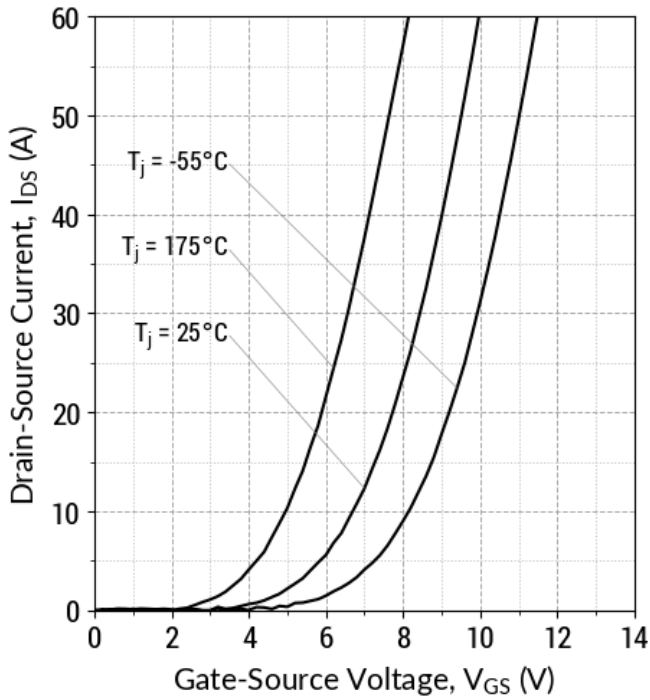

$I_D = f(V_{GS}, T_j); t_p = 100\ \mu\text{s}$

Fig 6: Typical $R_{DS(ON)}$ v/s Temperature

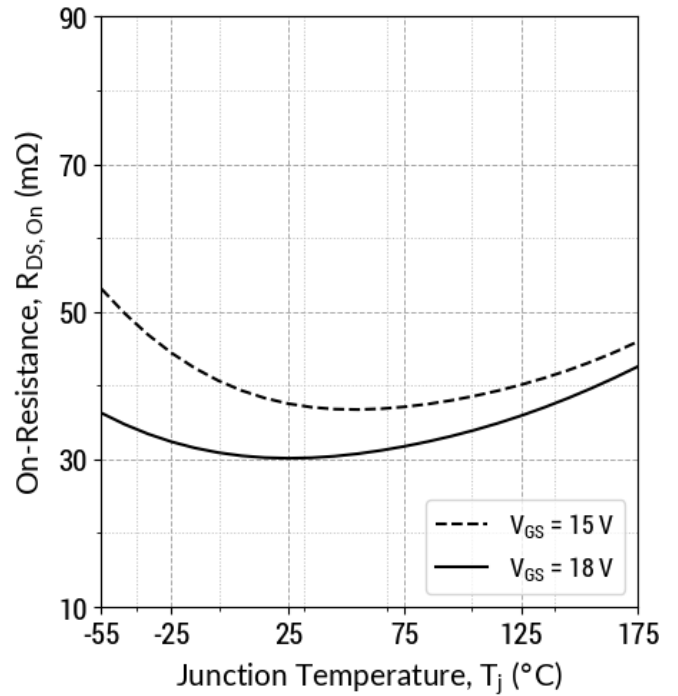

$R_{DS(ON)} = f(T_j, V_{GS}); t_p = 50\ \mu\text{s}; I_D = 26\text{ A}$

Fig 7: Typical $R_{DS(ON)}$ v/s Drain Current

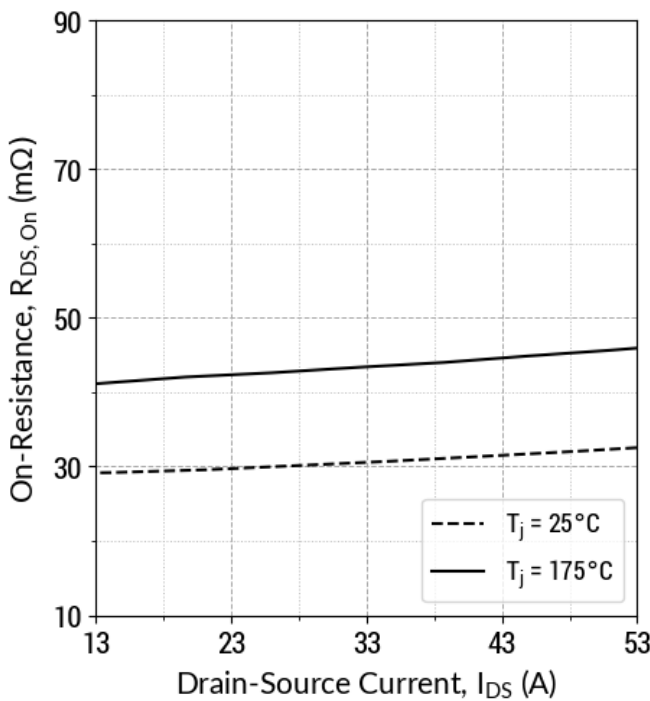

$R_{DS(ON)} = f(T_j, I_D); t_p = 50\ \mu\text{s}; V_{GS} = 18\text{ V}$

Fig 8: Typical Normalized $R_{DS(ON)}$ v/s Temperature

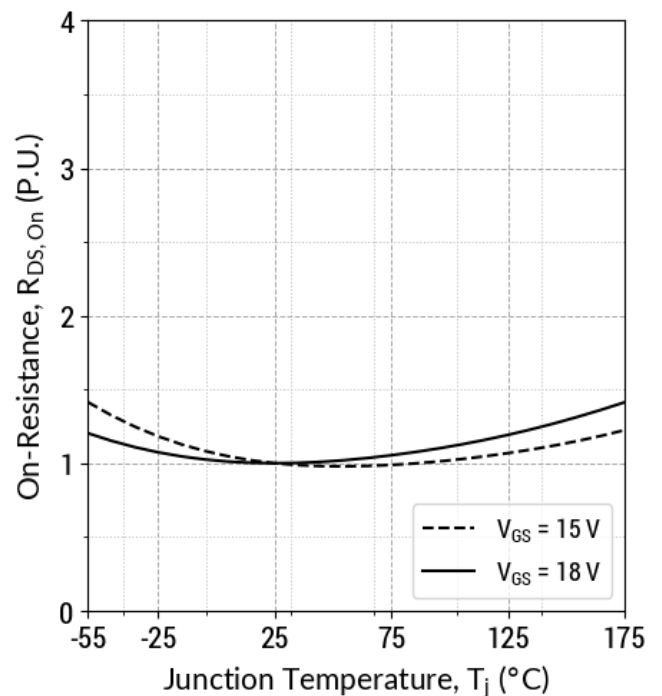

$R_{DS(ON)} = f(T_j); t_p = 50\ \mu\text{s}; I_D = 26\text{ A}$

Fig 9: Typical $R_{DS(ON)}$ v/s Gate Voltage

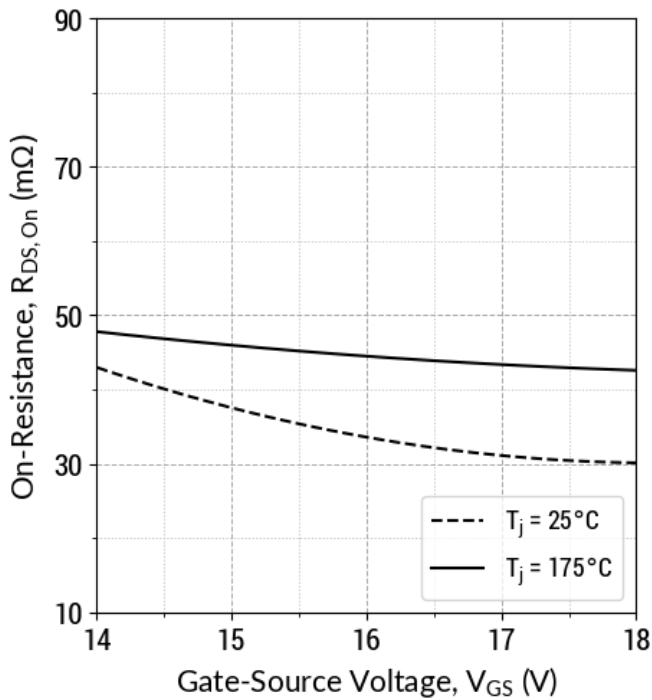

$R_{DS(ON)} = f(T_j, V_{GS}); t_p = 50 \mu\text{s}; I_D = 26 \text{ A}$

Fig 10: Typical Threshold Voltage Characteristics

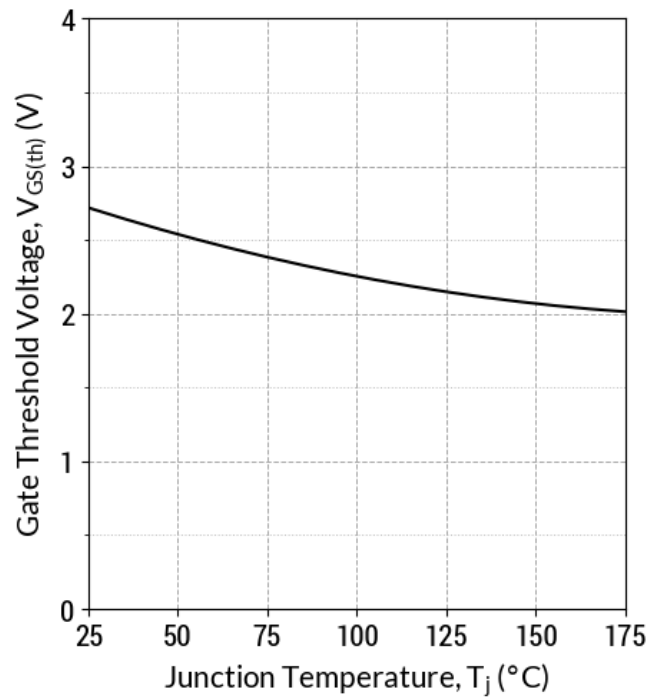

$V_{GS(th)} = f(T_j); V_{DS} = V_{GS}; I_D = 12 \text{ mA}$

Fig 11: Typical Gate Charge Characteristics

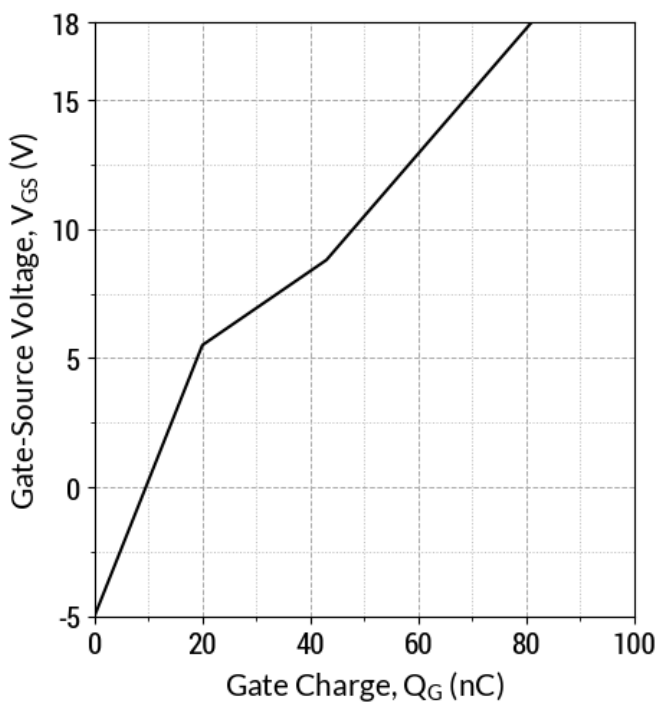

$I_D = 26 \text{ A}; V_{DS} = 400 \text{ V}; T_c = 25^\circ\text{C}$

Fig 12: Typical Capacitance v/s Drain-Source Voltage

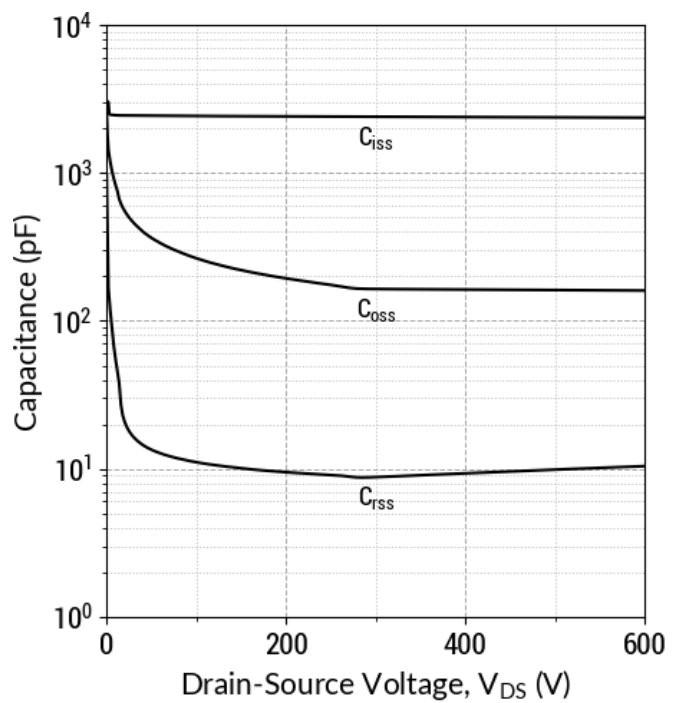

$f = 500 \text{ KHz}; V_{AC} = 25 \text{ mV}$

Fig 13: Output Capacitor Stored Energy

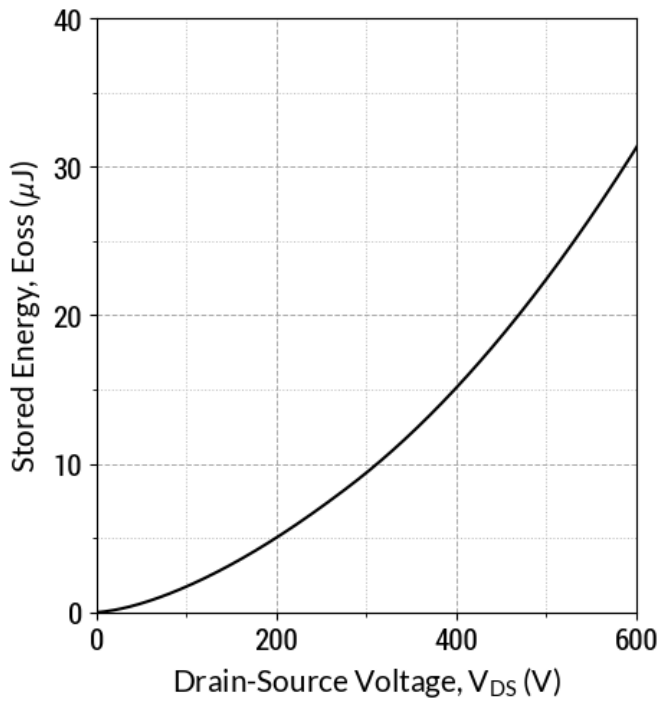

$E_{oss} = f(V_{DS})$

Fig 14: Max. Transient Thermal Impedance

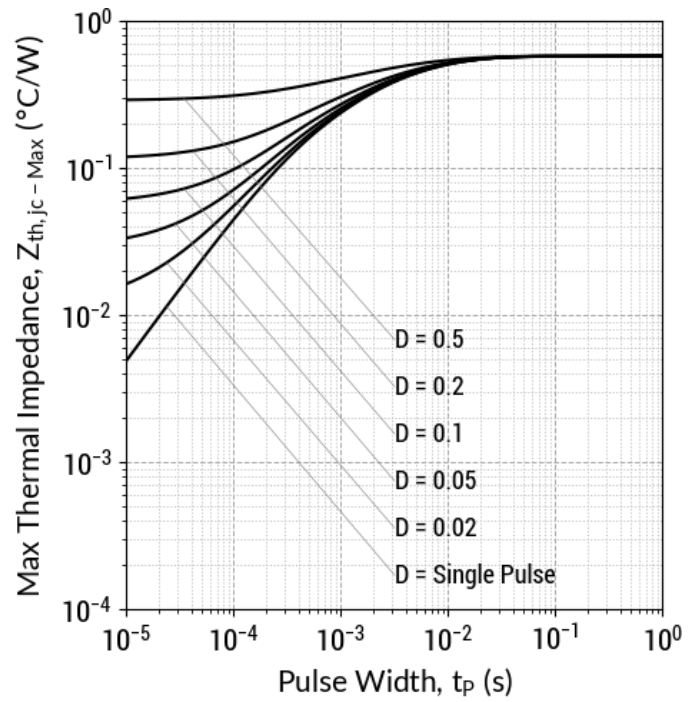

$Z_{th,jc} = f(t_p, D); D = t_p/T$

Fig 15: Safe Operating Area ($T_c = 25^{\circ}C$)

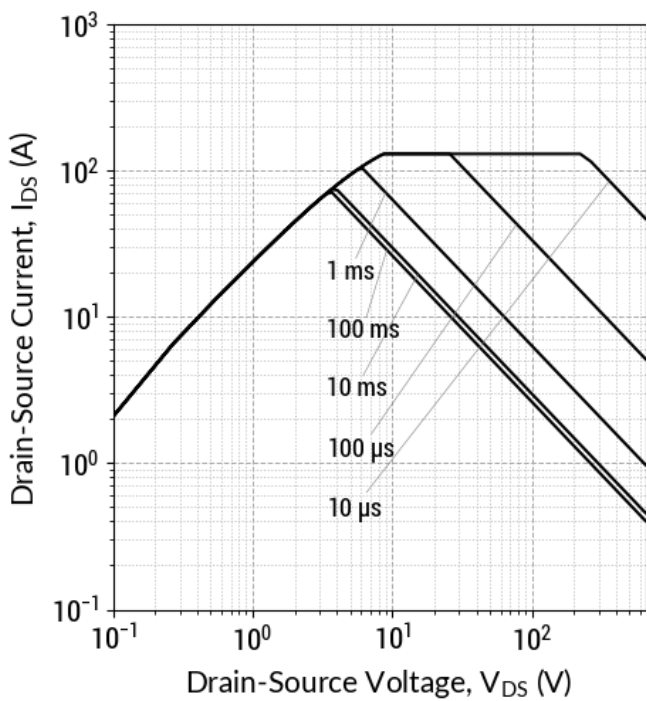

$I_D = f(V_{DS}, t_p); T_j \leq 175^{\circ}C; D = 0$

Fig 16: Current De-rating Curve

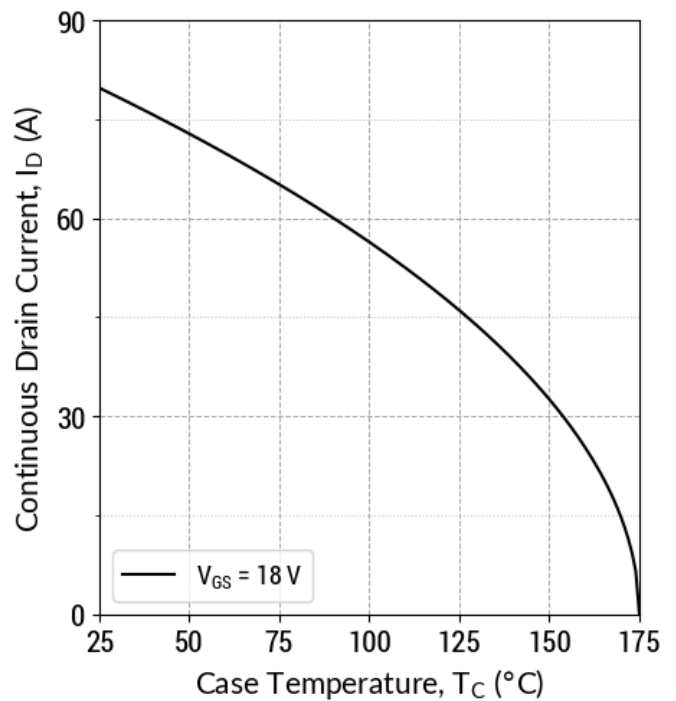

$I_D = f(T_C); T_j \leq 175^{\circ}C$

Fig 17: Power De-rating Curve

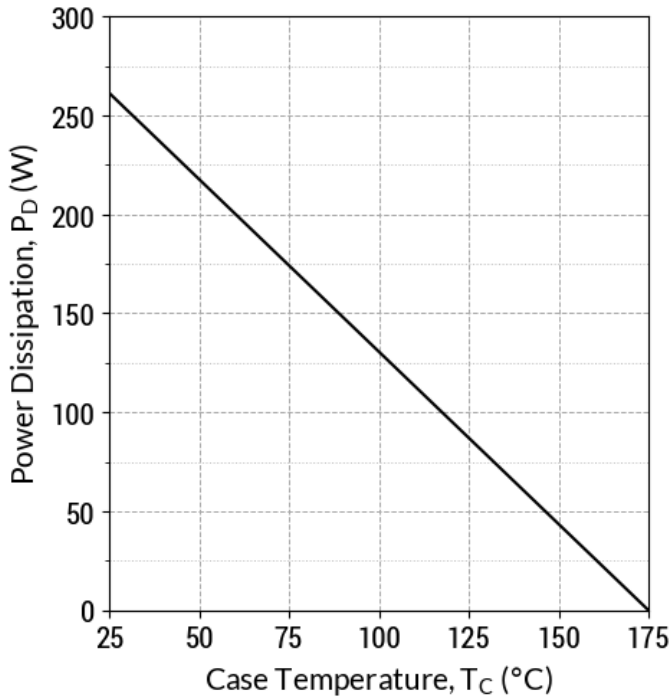

$P_D = f(T_C); T_j \leq 175^\circ\text{C}$

Fig 18: Typical Body Diode Characteristics ($T_j = 25^\circ\text{C}$)

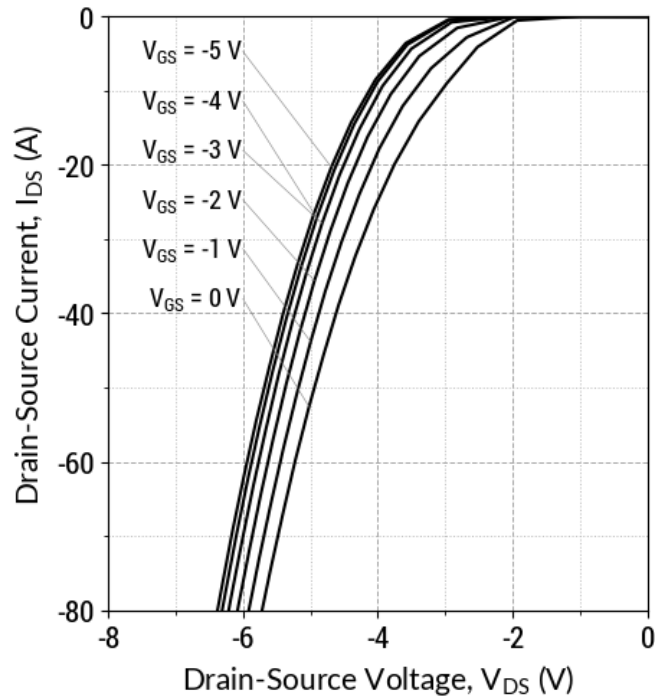

$I_D = f(V_{DS}, V_{GS}); t_P = 50 \mu\text{s}$

Fig 19: Typical Body Diode Characteristics ($T_j = 175^\circ\text{C}$)

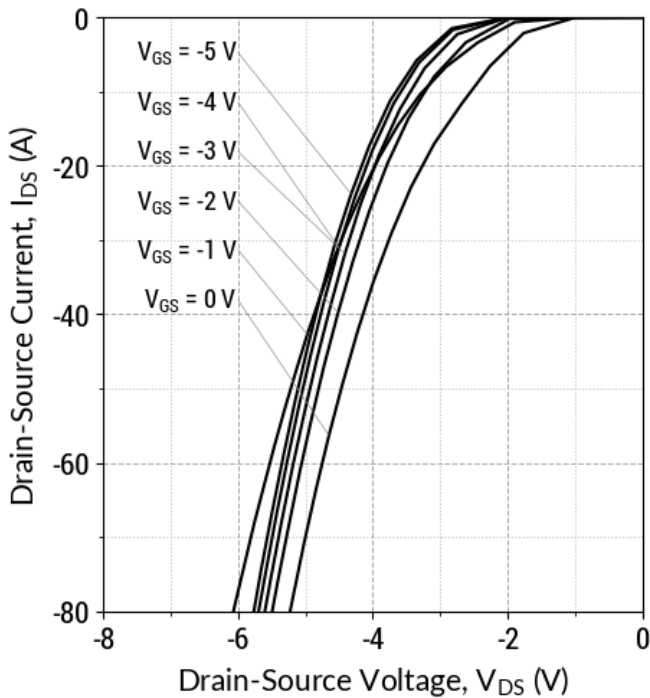

$I_D = f(V_{DS}, V_{GS}); t_P = 50 \mu\text{s}$

Fig 20: Typical Body Diode Characteristics ($T_j = -55^\circ\text{C}$)

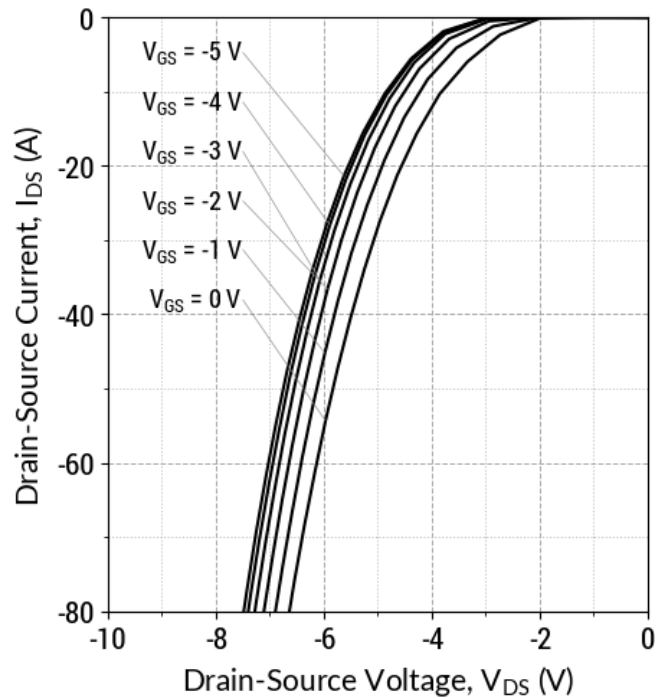

$I_D = f(V_{DS}, V_{GS}); t_P = 50 \mu\text{s}$

Fig 21: Typical Third Quadrant Characteristics ($T_j = 25^\circ\text{C}$)

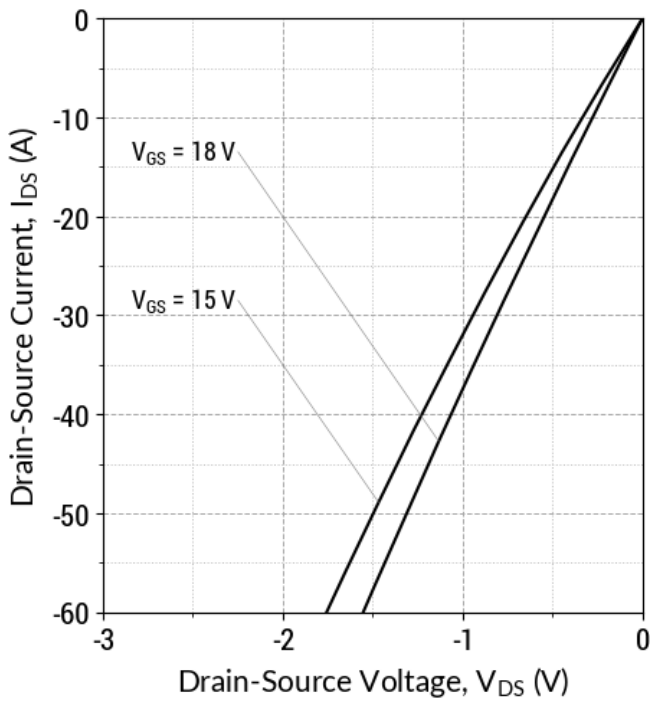

$I_D = f(V_{DS}, V_{GS}); t_P = 50 \mu\text{s}$

Fig 22: Typical Third Quadrant Characteristics ($T_j = 175^\circ\text{C}$)

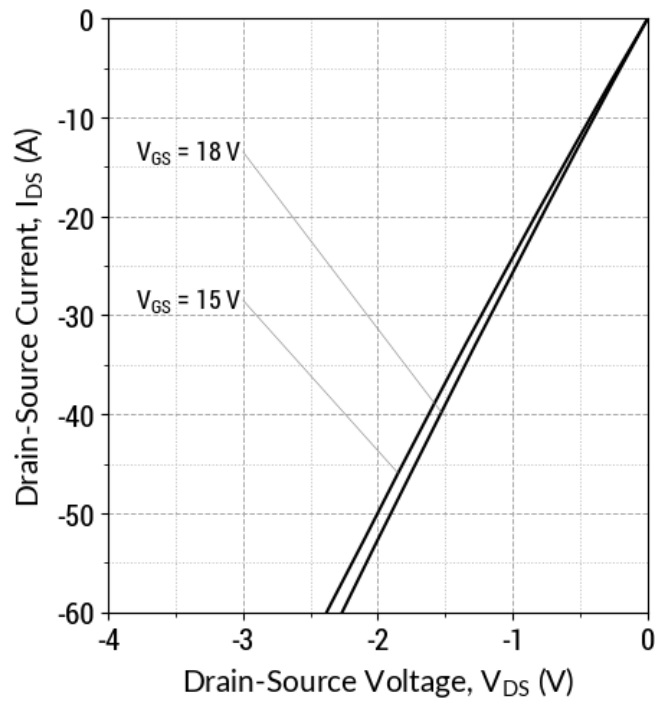

$I_D = f(V_{DS}, V_{GS}); t_P = 50 \mu\text{s}$

Fig 23: Typical Third Quadrant Characteristics ($T_j = -55^\circ\text{C}$)

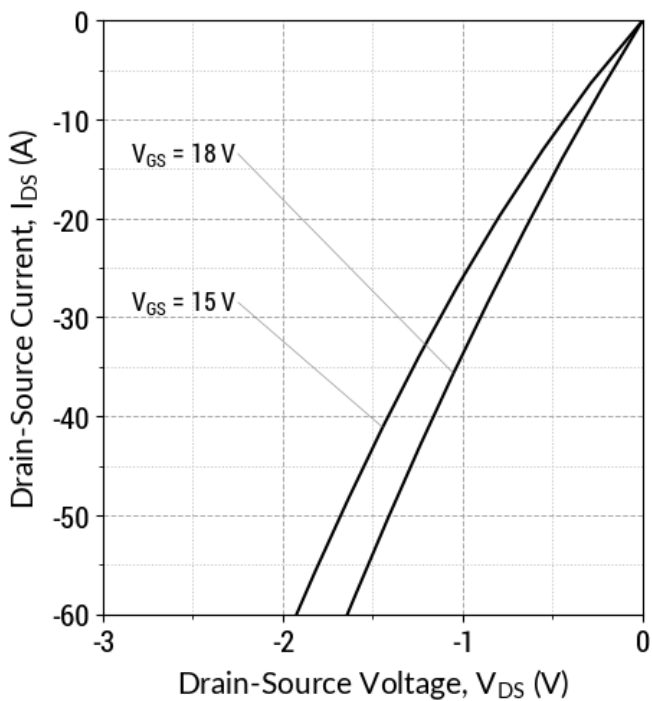

$I_D = f(V_{DS}, V_{GS}); t_P = 50 \mu\text{s}$

Fig 24: Inductive Switching Energy v/s Drain Current ($V_{DD} = 400\text{V}$)

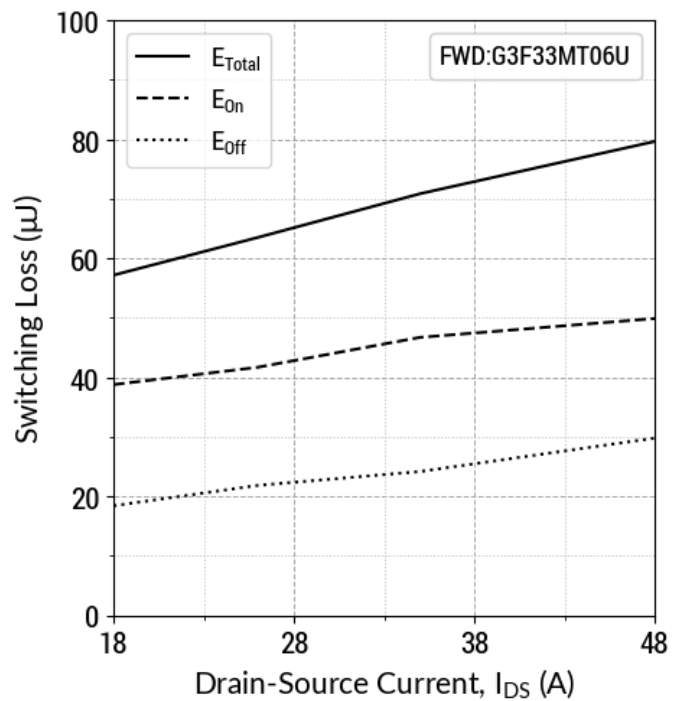

$T_j = 25^\circ\text{C}; V_{GS} = -5/+18\text{V}; R_{G(ext)} = 4.7 \Omega; L = 60.0 \mu\text{H}$

Fig 25: Inductive Switching Energy v/s $R_{G(ext)}$
($V_{DD} = 400V$)

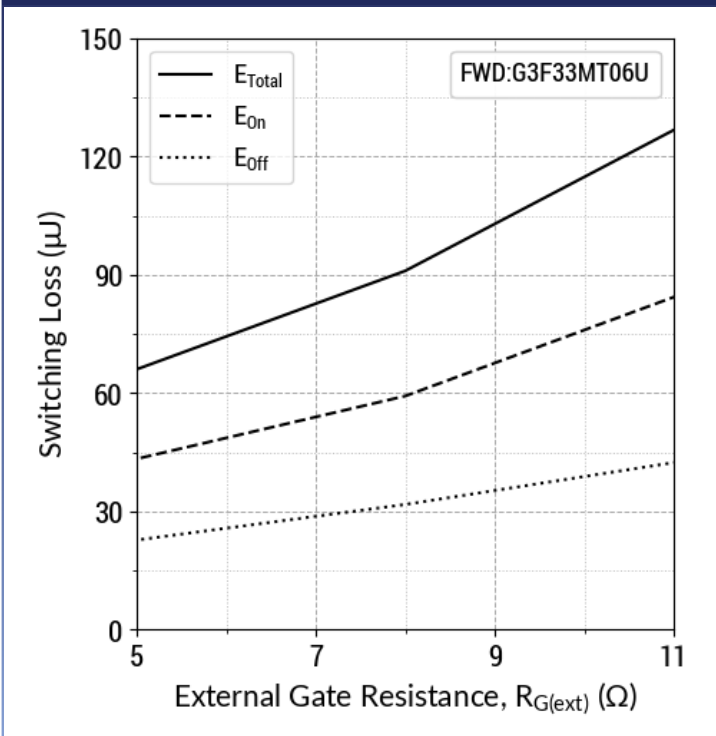

$T_j = 25^\circ C$; $V_{GS} = -5/+18V$; $I_{DS} = 26 A$; $L = 60.0\mu H$

Fig 26: Switching Time v/s $R_{G(ext)}$
($V_{DD} = 400V$)

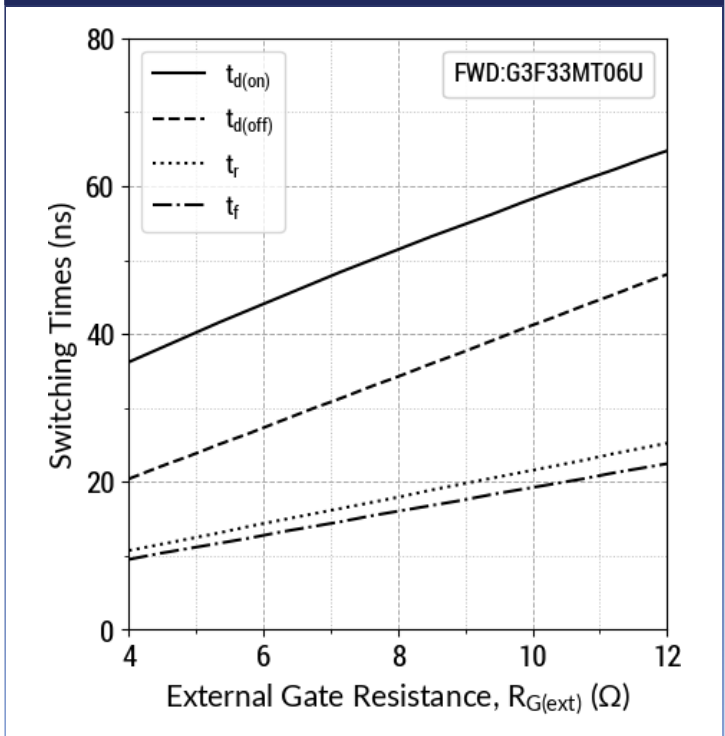

$T_j = 25^\circ C$; $V_{GS} = -5/+18V$; $I_{DS} = 26 A$; $L = 60.0\mu H$

Fig 27: Inductive Switching Energy v/s Temperature
($V_{DD} = 400V$)

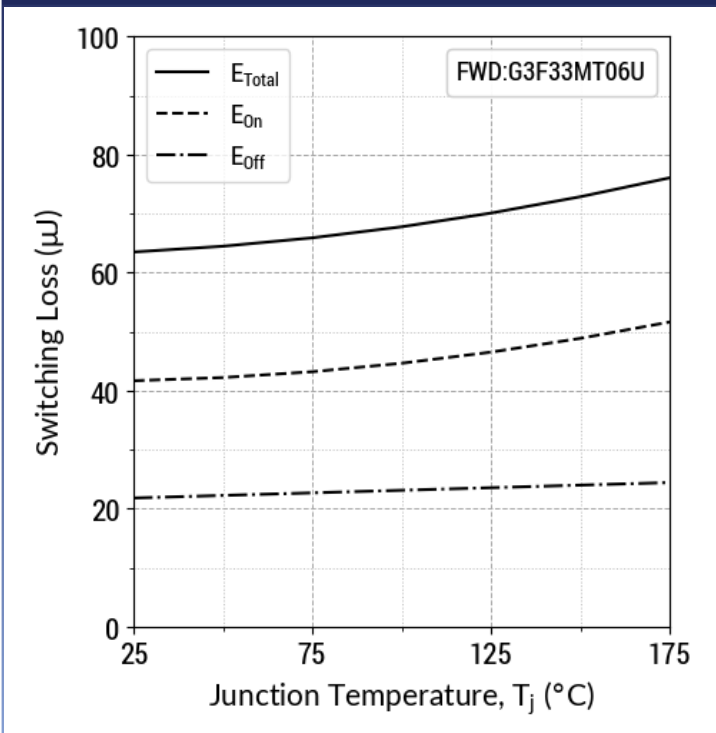

$T_j = 25^\circ C$; $V_{GS} = -5/+18V$; $R_{G(ext)} = 4.7 \Omega$; $I_{DS} = 26 A$; $L = 60.0\mu H$

Reverse Recovery Circuit

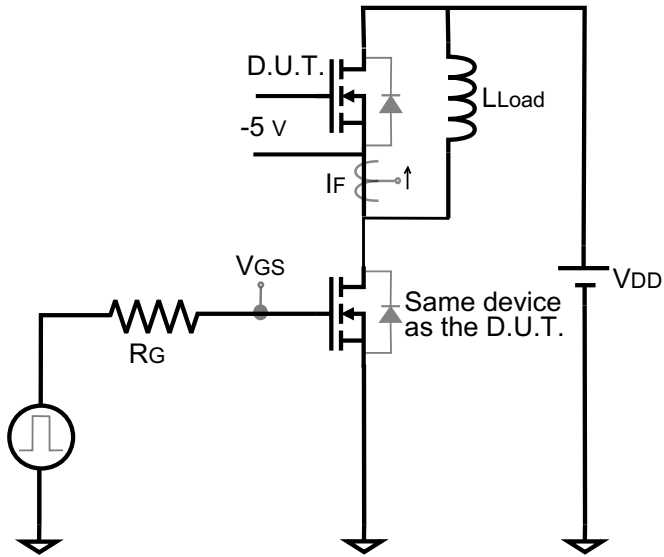

Reverse Recovery Waveform

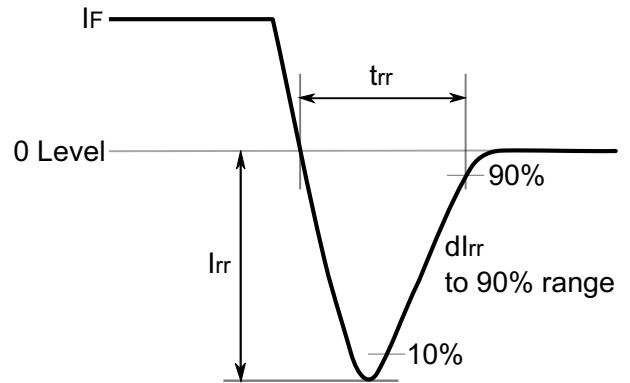

Package Dimensions

HV-T2PAK Package Outline

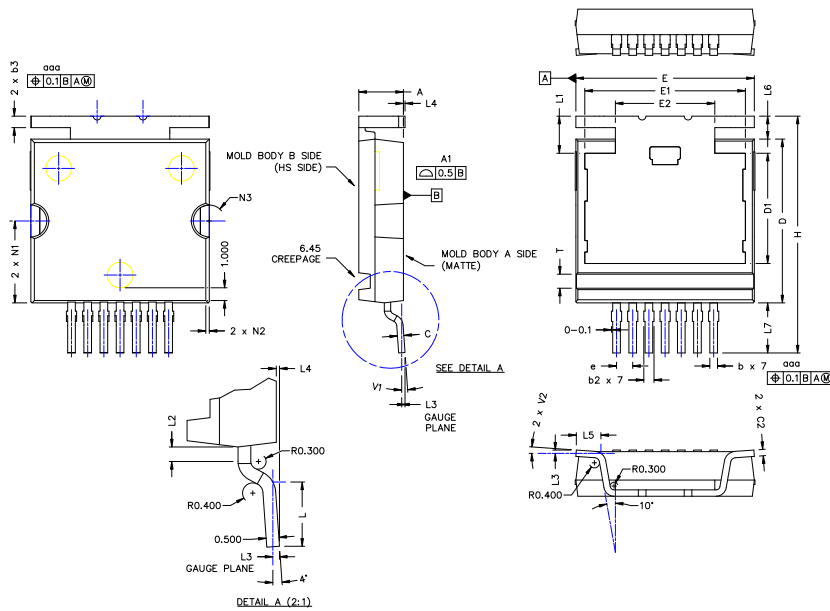

SYM	MIN	NOM	MAX
A	-	3.50	-
A1	-	-	0.05
b	-	0.60	-
b2	-	0.80	-
b3	-	0.90	-
c	-	0.50	-
c2	-	0.50	-
D	-	12.85	-
D1	8.55	8.65	8.75
E	13.90	14.00	14.10
E1	12.50	12.60	12.70
E2	-	7.80	-
e	-	1.27	-
H	18.38	18.58	18.78
aaa	-	-	0.10
L	2.42	2.52	2.62
L1	-	2.95	-
L2	0.47	0.57	0.67
L3	-	0.26	-
L4	0.075	0.125	0.175
L5	1.83	1.93	2.03
L6	1.70	1.80	1.90
L7	3.83	3.93	4.03
N1	-	6.43	-
N2	-	0.30	-
N3	-	1.25	-
T	-	1.1	-
V1	0°	4°	8°
V2	0°	4°	8°

- NOTES:
- ALL DIMENSIONS IN MILLIMETERS.
 - ALL METAL SURFACES WITH TIN PLATED EXCEPT AREA OF CUT AND HEATSINK.
 - ALL DIMENSIONS ARE PARTIAL AND SUBJECT TO CHANGE UPON DESIGN REVIEW.
 - DIMENSIONS EXCLUDED TIN PLATING THICKNESS.
GENERAL TIN PLATING THICKNESS: 15±5 UM.
 - GENERAL RADIUS OF EDGE AND CORNER: R IS 0.2 MM.
 - MOLD BODY A SIDE: Ra: 0.8 ~ 1.2 UM.
 - MOLD BODY B SIDE (HS SIDE): Ra: 0.8 ~ 1.2 UM.
 - UNLESS OTHERWISE SPECIFIED.
DECIMAL ANGULAR
X.X±0.1 X±1°
X.XX±0.05 X.XX±0.1°
X.XXX±0.025

NOTE

- CONTROLLED DIMENSION IS MILLIMETER.
- DIMENSIONS DO NOT INCLUDE END FLASH, MOLD FLASH, MATERIAL PROTRUSIONS.

Revision History

- Rev 24/Sep: Preliminary Specification

IMPORTANT NOTICES AND DISCLAIMERS

EXCEPT TO THE EXTENT THAT INFORMATION IN THIS DATA SHEET IS EXPRESSLY AND SPECIFICALLY WARRANTED IN WRITING BY NAVITAS SEMICONDUCTOR ("**NAVITAS**"), EITHER PURSUANT TO THE TERMS AND CONDITIONS OF THE LIMITED WARRANTY CONTAINED IN NAVITAS' STANDARD TERMS AND CONDITIONS OF SALE OR A WRITTEN AGREEMENT SIGNED BY AN AUTHORIZED NAVITAS REPRESENTATIVE, (1) ALL INFORMATION IN THIS DATA SHEET OR OTHER RELIABILITY AND TECHNICAL DATA, AND ANY OTHER DESIGN RESOURCES (INCLUDING REFERENCE DESIGNS), APPLICATION OR OTHER DESIGN ADVICE OR TOOLS, SAFETY INFORMATION AND OTHER RESOURCES, ARE PROVIDED "AS IS" AND WITH ALL FAULTS; AND (2) NAVITAS MAKES NO WARRANTIES OR REPRESENTATIONS AS TO ANY SUCH INFORMATION OR RESOURCES, IN THIS DATA SHEET OR OTHERWISE, AND HEREBY DISCLAIMS ALL WARRANTIES, EXPRESS AND IMPLIED, INCLUDING WITHOUT LIMITATION ANY IMPLIED WARRANTIES OF MERCHANTABILITY, FITNESS FOR A PARTICULAR PURPOSE OR NON-INFRINGEMENT OF THIRD-PARTY INTELLECTUAL PROPERTY RIGHTS.

CUSTOMER RESPONSIBILITIES. This data sheet and other design resources and information provided by Navitas are intended only for technically trained and skilled developers designing with Navitas- or GeneSiC-branded products ("**Products**"). Performance specifications and the operating parameters of Products described herein are determined in the independent state and may not perform the same way when installed in customer products. The customer (or other user of this data sheet) is solely responsible for (a) designing, validating and testing the products and systems in which Products are incorporated; (b) designing, validating and testing the application in which Products are incorporated; (c) ensuring the application meets applicable standards and any safety, security, regulatory or other requirements; (d) evaluating the suitability of Products for the intended application and the completeness of the information in this data sheet with respect to such application; (e) procuring and/or developing production firmware, if applicable; and (f) completing system qualification, compliance and safety testing, EMC testing, and any automotive, high-reliability or other system qualifications that apply.

NON-AUTHORIZED USES OF PRODUCTS. Except to the extent expressly provided in a writing signed by an authorized Navitas representative, Products are not designed, authorized or warranted for use in extreme or hazardous conditions; aircraft navigation, communication or control systems; aircraft power and propulsion systems; air traffic control systems; military, weapons, space-based or nuclear applications; life-support devices or systems, including but not limited to devices implanted into the human body and emergency medical equipment; or applications where product failure could lead to death, personal injury or severe property or environmental damage. The customer or other persons using Products in such applications without Navitas' agreement or acknowledgement, as set forth in a writing signed by an authorized Navitas representative, do so entirely at their own risk and agree to fully indemnify Navitas for any damages resulting from such improper use. In order to minimize risks associated with such applications, you should provide adequate design and operating safeguards.

CHANGES TO, AND USE OF, THIS DATA SHEET. This data sheet and accompanying information and resources are subject to change without notice. Navitas grants you permission to use this data sheet and accompanying resources only for the development of an application that uses the Products described herein and subject to the notices and disclaimers set forth above. Any other use, reproduction or display of this data sheet or accompanying resources and information is prohibited. No license is granted to any Navitas intellectual property right or to any third-party intellectual property right. Navitas disclaims any responsibility for, and you will fully indemnify Navitas and its representatives against, any claims, damages, costs, losses and liabilities arising out of your use of this data sheet and any accompanying resources and information.

TERMS AND CONDITIONS. All purchases and sales of Products are subject to [Navitas' Standard Terms and Conditions of Sale](#), including the limited warranty contained therein, unless other terms and conditions have been agreed in a writing signed by an authorized Navitas representative. This data sheet, and Navitas' provision of this data sheet or other information and resources, do not expand or otherwise alter those terms and conditions.

Navitas, GeneSiC, the Navitas and GeneSiC logos, GaNFast, GaNSafe, SICPAK and other Navitas marks used herein are trademarks or registered trademarks of Navitas Semiconductor Limited or its affiliates. Other trademarks used herein are the property of their respective owners.

Copyright © 2024 Navitas Semiconductor Limited and affiliates. All rights reserved.